

**FİYAT
KATALOĐU**



el-max

2022

İndeks

MALZEME KODU	SAYFA NO	B.FİYATI
EMC-9-63-2	6	3,60 \$
EMC-9-63-4	6	3,60 \$
EMC-9-63-6	6	3,13 \$
EMC-9-63-10	6	3,13 \$
EMC-9-63-16	6	3,13 \$
EMC-9-63-25	6	3,13 \$
EMC-9-63-32	6	3,23 \$
EMC-9-63-40	6	3,23 \$
EMC-9-63-50	6	3,60 \$
EMC-9-63-63	6	3,60 \$
EMC-3-9-63-10	7	10,56 \$
EMC-3-9-63-16	7	10,56 \$
EMC-3-9-63-20	7	10,56 \$
EMC-3-9-63-25	7	10,56 \$
EMC-3-9-63-32	7	11,66 \$
EMC-3-9-63-40	7	11,66 \$
EMC-3-9-63-50	7	13,87 \$
EMC-3-9-63-63	7	13,87 \$
EMC-3-9-63-80	8	42,00 \$
EMC-3-9-63-100	8	44,00 \$
EMC-3-9-63-125	8	46,00 \$
EMC-4-9-63-16	9	15,72 \$
EMC-4-9-63-25	9	15,72 \$
EMC-4-9-63-32	9	16,20 \$
EMC-4-9-63-40	9	16,20 \$
EMC-4-9-63-50	9	18,00 \$
EMC-4-9-63-63	9	18,00 \$
ERB-2-25-30	10	22,56 \$
ERB-2-25-300	10	22,56 \$
ERB-2-32-30	10	22,56 \$
ERB-2-32-300	10	22,56 \$
ERB-2-40-30	10	22,56 \$
ERB-2-40-300	10	22,56 \$
ERB-4-25-30	10	31,38 \$
ERB-4-25-300	10	31,38 \$
ERB-4-32-30	10	31,38 \$
ERB-4-32-300	10	31,38 \$
ERB-4-40-30	10	31,38 \$
ERB-4-40-300	10	31,38 \$
ERB-4-63-30	10	31,38 \$
ERB-4-63-300	10	31,38 \$
UNMC-12	11	14,60 \$
UNMC-18	11	20,00 \$
UNMC-22	11	20,60 \$
UNMC-32	11	32,75 \$
UNMC-40	11	37,75 \$
UNMC-65	11	58,00 \$
UNMC-85	11	88,00 \$
ELX-D0910	12	11,85 \$
ELX-D0901	12	11,85 \$
ELX-D1210	12	12,15 \$
ELX-D1201	12	12,15 \$
3LX-D1810	12	14,35 \$
ELX-D1801	12	14,35 \$
ELX-D2501	12	20,30 \$
ELX-D2501	12	20,30 \$
ELX-D3210	12	26,80 \$
ELX-D115	13	169,00 \$
ELX-D150	13	180,00 \$
ELX-D170	13	244,00 \$
LAD-8N11	13	10,60 \$
AU-2	14	3,76 \$
AU-4	14	6,25 \$
ELX-DN11	14	3,75 \$
ELX-DN22	14	6,25 \$
UNMR-32-10	15	14,30 \$
UNMR-32-13	15	14,30 \$
UNMR-32-18	15	14,30 \$
UNMR-32-25	15	14,30 \$
UNMR-32-32	15	17,20 \$
UNMR-85-65	15	24,30 \$
UNMR-85-85	15	24,30 \$
UNTR1-D13-25	15	11,88 \$
UNTR1-D13-4	15	11,88 \$
UNTR1-D13-6	15	11,88 \$
UNTR1-D13-8	15	11,88 \$
UNTR1-D13-10	15	11,88 \$
UNTR1-D13-13	15	11,88 \$
UNTR1-D13-18	15	11,88 \$
UNTR1-D13-25	15	11,88 \$
UNTR1-D13-32	15	11,88 \$
UNSR1-D59-4	15	16,88 \$
UNSR1-D59-6.3	15	16,88 \$
UNSR1-D59-10	15	16,88 \$
UNSR1-D59-16	15	16,88 \$
UNSR1-D59-25	15	20,00 \$
UNSR1-D59-40	15	20,00 \$
UNSR1-D59-57	15	20,00 \$
UNSR1-D59-63	15	20,00 \$
MK-910	16	13,75 \$
MK-901	16	13,75 \$
UNTR-MK	16	11,42 \$
ELX-2P-25A	16	14,38 \$
ELX-2P-40A	16	25,00 \$
ELX-4P-40A	16	35,00 \$
EMK-R-4	16	31,88 \$
EMK-R-6.3	16	31,88 \$
EMK-R-10	16	31,88 \$
EMK-R-14	16	31,88 \$
EMK-R-18	16	31,88 \$
EMK-R-23	16	31,88 \$
EMK-R-25	16	31,88 \$
EMK-R-32	16	31,88 \$
EDA-16	16	16,46 \$
ELX-BOX-1	17	1,12 \$
ELX-BOX1-K	17	1,85 \$
LAYSDB2BOX1	17	1,12 \$

MALZEME KODU	SAYFA NO	B.FİYATI
LAYSDB2BOX2	17	2,25 \$
LAYSDB2BOX3	17	2,75 \$
LAYSDB2BOX4	17	3,30 \$
LAYSDB2BOX5	17	4,18 \$
LAYSDB2BOX6	17	4,50 \$
LAYSDB2BOX7	17	4,83 \$
ELX-BX1-AS	18	3,37 \$
ELX-BX1-ASK	18	3,50 \$
ELX-ALM-1	18	3,00 \$
ELX-K	18	0,80 \$
ELX-PAS-1	19	8,00 \$
ELX-BYP-B-24 VDC	19	4,05 \$
ELX-KDRR-EG61	19	4,85 \$
ELX-KAB-EA21	19	3,46 \$
ELX-BX5-4	20	10,30 \$
ELX-BX5-5	20	11,20 \$
ELX-BX6-5P	20	13,50 \$
ELX-BX6-6	20	15,00 \$
ELX-ELP-RK	21	10,00 \$
ELX-EL3B-YLS-RK	21	17,00 \$
ELX-EL3B-PLS-RK	21	20,50 \$
ELX-ELK5	21	13,00 \$
ELX-EL3BY-RK	21	F. SORUNUZ
ELX-ELK4	22	11,25 \$
ELX-BX-7K	22	17,00 \$
ELX-BX-7P	22	18,50 \$
ELX-KY-10	22	21,10 \$
ELX-BX6-6N	23	17,00 \$
ELX-AKDMI-7	23	21,10 \$
ELX-2MSK-K5	23	F. SORUNUZ
ELX-BF	24	F. SORUNUZ
ELX-ASP	26	F. SORUNUZ
ELX-30-EMC	26	F. SORUNUZ
ELX-FD	26	F. SORUNUZ
ELX-DS	27	F. SORUNUZ
ELX-DD-12	27	F. SORUNUZ
ELX-DD-24	27	F. SORUNUZ
ELX-F-120-24	28	F. SORUNUZ
ELX-F-120-220	28	F. SORUNUZ
ELX-F-172-220	28	F. SORUNUZ
DMX-T180	28	F. SORUNUZ
DMX-T240	28	F. SORUNUZ
DMX-T300	28	F. SORUNUZ
ELX-LED-SSNB	29	F. SORUNUZ
ELX-LTFA	29	F. SORUNUZ
ELX-LTFA	29	F. SORUNUZ
ELX-LEA	29	F. SORUNUZ
NÜVE	30	F. SORUNUZ
KLEMENS AKS	30	F. SORUNUZ
ELX-STA	30	F. SORUNUZ
OTOMAT RAYI	30	F. SORUNUZ
0.80 NYA	31	F. SORUNUZ
ELX-DT13	31	F. SORUNUZ
PANO PRİZİ	32	F. SORUNUZ
TRAFO	32	F. SORUNUZ
3X25 MAKİNA PRİZİ	32	F. SORUNUZ
1X16 PANO PRİZİ	32	F. SORUNUZ
ELX-PS	33	F. SORUNUZ
BYPASS	33	F. SORUNUZ
NEMLİYER GRUBU	33	F. SORUNUZ
ELX-BKA	33	F. SORUNUZ
ELX-LED	33	F. SORUNUZ
ŞEYAR EL LAMBASI	34	F. SORUNUZ
PANO SİRALI	34	F. SORUNUZ
PLASTİK SİRAL	34	F. SORUNUZ
KLEMENS	34	F. SORUNUZ
KRC KARTI	35	F. SORUNUZ
DIOT KARTI	35	F. SORUNUZ
MH-70-MH-80	35	F. SORUNUZ
REVIZYON KARTI	35	F. SORUNUZ
KLEMENS KARTI	35	F. SORUNUZ
ÇİFT YÖNLÜ HABERLEŞME	36	F. SORUNUZ
DELİKLİ KABLO KANALI	37	F. SORUNUZ
KAPALI KABLO KANALI	37	F. SORUNUZ
SAC KABLO KANALI	37	F. SORUNUZ
KANAL KROSESİ	37	F. SORUNUZ
30MM SESLİ BUZZER	38	26,25 \$
30MM SESLİ BUZZER	38	30,0 \$
30MM SESLİ BUZZER	38	26,25 \$
30MM SESLİ BUZZER	38	30,0 \$
22X7 MIKNATIS	38	0,14 \$
10CM ŞERİT MIKNATIS	38	0,69 \$
30CM ŞERİT MIKNATIS	38	2,08 \$
KURU TIP AKÜ	38	F. SORUNUZ
KD-35 DİYOT	38	1,17 \$
KD-50 DİYOT	38	2,05 \$
MINİ ANAHTARLAR	38	F. SORUNUZ
ELX-TR-24-15	39	9,25 \$
ELX-TR-24-25	39	12,5 \$
ELX-TR-24-60	39	17,22 \$
ELX-TR-24-100	39	22,5 \$
ELX-TR-24-120	39	23,40 \$
ELX-TR-24-150	39	29,50 \$
ELX-TR-24-200	39	33,90 \$
ELX-TR-24-250	39	38,50 \$
ELX-TR-24-350	39	45,00 \$
ELX-TR-24-400	39	49,00 \$
LAY-5-EA-31	40	1,20 \$
EA-42	40	1,20 \$
EA-51	40	1,20 \$
EA-21	40	1,20 \$
DB2-EA-21-i	40	1,25 \$
EA-51-i	40	1,25 \$
EA-61	40	1,25 \$
EA3341	40	1,25 \$
EA3351	40	1,25 \$
ED21	40	1,31 \$

MALZEME KODU	SAYFA NO	B.FİYATI
ED33	40	2,38 \$
ED53	40	2,48 \$
EL8325	41	3,30 \$
ES542	41	1,80 \$
ES442	41	1,80 \$
ES142	41	3,94 \$
EC42	41	1,80 \$
EC31	41	1,80 \$
EG41	41	3,90 \$
E661	41	3,90 \$
E673	41	4,20 \$
BA31	42	1,875 \$
BA42	42	1,875 \$
BA51	42	1,875 \$
BA21	42	1,875 \$
BA3341	42	2,10 \$
BA3351	42	2,10 \$
B5542	42	2,62 \$
BL8325	42	3,94 \$
BD21	43	2,16 \$
BD33	43	2,76 \$
B641	43	4,13 \$
PA22	43	16,5 \$
BE101	43	0,61 \$
BE102	43	0,61 \$
PT5K	43	7,56 \$
PT10K	43	7,56 \$
ELX-2M10	44	2,40 \$
2M01	44	2,40 \$
2M11	44	2,40 \$
2M21	44	2,40 \$
2M31	44	2,40 \$
2M41	44	2,40 \$
ELX-2M1011	44	2,80 \$
2M1012	44	2,80 \$
2M1013	44	2,80 \$
2M1014	44	2,80 \$
ELX-2M10L	44	4,18 \$
2M01L	44	4,18 \$
2M11L	44	4,18 \$
2M21L	44	4,18 \$
2M31L	44	4,18 \$
ELX-2M-10L-110	44	4,18 \$
2M01L-110	44	4,18 \$
2M11L-110	44	4,18 \$
2M21L-110	44	4,18 \$
2M31L-110	44	4,18 \$
ELX-2M-10L-24	44	4,18 \$
2M01L24	44	4,18 \$
2M11L24	44	4,18 \$
2M21L24	44	4,18 \$
2M31L24	44	4,18 \$
ELX-2M-10KL	45	2,80 \$
2M-20KL	45	3,80 \$
2M-10KY	45	3,10 \$
2M-20KY	45	4,15 \$
2M-10AN	45	4,15 \$
2M-20AN	45	5,14 \$
ELX-2M-10LK	46	4,65 \$
2M-01LK	46	4,65 \$
2M-11LK	46	4,65 \$
ELX-2M-10LK-110	46	4,65 \$
2M-01LK-110	46	4,65 \$
2M-11LK-110	46	4,65 \$
ELX-2M-10LK-24	46	4,65 \$
2M-01LK-24	46	4,65 \$
2M-11LK-24	46	4,65 \$
ELX-2M-20LK	46	5,40 \$
2M-02LK	46	5,40 \$
2M-21LK	46	5,40 \$
ELX-2M-20LK-110	46	5,40 \$
2M-02LK-110	46	5,40 \$
2M-21LK-110	46	5,40 \$
ELX-2M-20LK-24	46	5,40 \$
2M-02LK-24	46	5,40 \$
2M-21LK-24	46	5,40 \$
ELX-2M-01AS	46	3,30 \$
ELX-2M-11TBR	46	4,30 \$
ELX-2M-11TBL	46	5,70 \$
ELX-2M-11A	46	1,04 \$
ELX-2M-01A	46	1,04 \$
LAYS-AA11	47	2,40 \$
AA21	47	2,40 \$
AA31	47	2,40 \$
AA51 (ZILLI)	47	2,70 \$
AA61 (OKLU)	47	2,70 \$
AA42	47	2,40 \$
LAYS-AA3341	47	2,70 \$
LAYS-AA3351	47	2,70 \$
LAYS-AL8325	47	6,30 \$
LAYS-AD21	47	3,20 \$
LAYS-AD33	47	4,30 \$
LAYS-ASS42	48	4,30 \$
LAYS-AG21	48	6,20 \$
LAYS-AG33	48	7,20 \$
LAYS-AW3175	48	5,96 \$
AW3375	48	5,96 \$
AW3575	48	5,96 \$
AW3675	48	5,96 \$
AW3475	48	5,96 \$
AW3175-24	48	5,96 \$
3375-24	48	5,96 \$
3575-24	48	5,96 \$
3675-24	48	5,96 \$
3475-24	48	5,96 \$
LAYS-AK-124L	48	8 \$
LAYS-AK-123L	48	8 \$



İndeks

MALZEME KODU	SAYFA NO	B.FİYATI
LAYS-AK-125L	48	8 \$
AK-124L-24	48	8 \$
AK-123L-24	48	8 \$
AK-125L-24	48	8 \$
LAYS-AK-324L	48	8 \$
AK-323L	48	8 \$
AK-325L	48	8 \$
LAYS-AK-324L-24	48	8 \$
AK-323L-24	48	8 \$
AK-325L-24	48	8 \$
LAYS-BE101	49	1,10 \$
BE102	49	1,10 \$
ESS0-12-24	49	5 \$
AD16-22-SMR	49	2,5 \$
AD16-22-SMR-24	49	2,5 \$
AD22-22DS-R	49	0,80 \$
AD22-22DS-G	49	0,80 \$
AD22-22DS-Y	49	0,80 \$
AD22-22DS-B	49	1,19 \$
AD22-22DS-W	49	1,19 \$
22DS-R-24	49	0,80 \$
22DS-G-24	49	0,80 \$
22DS-Y-24	49	0,80 \$
22DS-B-24	49	1,19 \$
22DS-W-24	49	1,19 \$
22MM LEDLİ VOLTMETRE	50	3,88 \$
LEDLİ VOLT-AMPER	50	9,50 \$
LEDLİ AMPERMETRE	50	7,77 \$
XCK-SUM-211	51	5,98 \$
XCK-SUM-331	51	5,42 \$
XCK-SUM-332RS	51	5,42 \$
XCK-SIM-411	52	5,98 \$
SEP121	52	5,98 \$
SIM311	52	5,98 \$
SEM121	52	5,98 \$
SEM122	52	6,06 \$
SEM123	52	6,06 \$
SEL123	53	5,14 \$
SEL123R	53	7,22 \$
SOM101	53	6,29 \$
SOM102	53	6,29 \$
CSA001	54	15,30 \$
CSA003	54	15,30 \$
CSA004	54	15,30 \$
CSA012	54	15,30 \$
CSA031	54	15,30 \$
CSA061	54	15,30 \$
CSA071	54	15,30 \$
15G0B	55	3,35 \$
15G022B	55	3,60 \$
15G021B	55	3,60 \$
15GWB	55	3,33 \$
15GW22B	55	3,05 \$
15GW3B	55	4,73 \$
15GW2B	56	3,33 \$
XAPY	56	1,24 \$
15-1C25	57	1,47 \$
151-1C25	57	1,47 \$
152-1C25	57	1,47 \$
153-1C25	57	1,47 \$
154-1C25	57	1,47 \$
155-1C25	57	1,47 \$
156-1C25	57	1,47 \$
ELX-IY-3005	58	0,102 ₺
IY3007	58	0,102 ₺
IY3010	58	0,102 ₺
IY3015	58	0,112 ₺
IY3025	58	0,153 ₺
IY3040	58	0,249 ₺
IY3060	58	0,313 ₺
IY3100	58	0,416 ₺
IY3160	58	0,620 ₺
IY3250	58	1,20 ₺
IY3350	58	1,308 ₺
IY3500	58	2,59 ₺
ELX-IY2005	58	0,102 ₺
IY2007	58	0,102 ₺
IY2010	58	0,102 ₺
IY2015	58	0,112 ₺
IY2025	58	0,153 ₺
IY2040	58	0,249 ₺
IY2060	58	0,313 ₺
IY2100	58	0,416 ₺
IY2160	58	0,620 ₺
IY2250	58	1,20 ₺
IY2350	58	1,308 ₺
IY2500	58	2,59 ₺
ELX-CY23005	58	0,2 ₺
CY23007	58	0,205 ₺
CY23010	58	0,217 ₺
CY23015	58	0,264 ₺
CY23025	58	0,433 ₺
CY23040	58	0,504 ₺
CY23060	58	0,626 ₺
CY23100	58	0,956 ₺
CY23160	58	1,188 ₺
ELX-YU301	59	0,346 ₺
YU401	59	0,520 ₺
YU501	59	0,530 ₺
YU601	59	0,775 ₺
YU801	59	0,779 ₺
ELX-YU302	59	0,590 ₺
YU402	59	0,590 ₺
YU502	59	0,600 ₺
YU602	59	0,850 ₺
YU802	59	0,850 ₺
YU1002	59	0,860 ₺

MALZEME KODU	SAYFA NO	B.FİYATI
ELX-YU406	59	1,38 ₺
YU506	59	1,38 ₺
YU606	59	1,55 ₺
YU806	59	1,94 ₺
YU1006	59	1,95 ₺
YU1206	59	1,97 ₺
ELX-CU-3001	59	0,495 ₺
CU4001	59	0,505 ₺
CU5001	59	0,519 ₺
CU6001	59	0,577 ₺
ELX-CU-3002	60	0,540 ₺
CU4002	60	0,560 ₺
CU5002	60	0,565 ₺
CU6002	60	0,759 ₺
ELX-CU-4006	60	1,25 ₺
CU5006	60	1,28 ₺
CU6006	60	1,70 ₺
CU8006	60	1,95 ₺
ELX-K-101	60	0,569 ₺
K102	60	0,670 ₺
K106	60	1,60 ₺
ELX-BD-1040	60	1,52 ₺
BD2050	60	1,70 ₺
BD5050	60	2,10 ₺
ELX-BE-1040	61	1,27 ₺
BE2050	61	1,45 ₺
BE5050	61	1,95 ₺
ELX-FDEB-1861	61	1,55 ₺
FDEB2862	61	1,55 ₺
ELX-FFD-1488	61	0,700 ₺
FFD1638	61	0,940 ₺
FFD2488	61	0,720 ₺
FFD2638	61	0,940 ₺
FFD5638	61	1,030 ₺
ELX-FD-1488	62	0,55 ₺
FD1638	62	0,71 ₺
FD2638	62	0,71 ₺
FD5638	62	0,87 ₺
ELX-FE-1288	63	0,49 ₺
FE1488	63	0,49 ₺
FE1638	63	0,59 ₺
FE2488	63	0,49 ₺
FE2638	63	0,650 ₺
FE5638	63	0,770 ₺
ELX-SF10	63	0,592 ₺
SF2D	63	0,592 ₺
SF1-2D	63	0,362 ₺
SF1-DMINI	63	0,459 ₺
SF1-DKILIF	63	0,281 ₺
ELX-SF-1ECK	63	0,611 ₺
SF1EU1	63	0,769 ₺
ELX-SKN-2.5	63	0,586 ₺
SKN4	63	1,107 ₺
SKN6	63	1,690 ₺
SKN8	63	1,690 ₺
SKN10	63	1,932 ₺
SKPE-1606	64	0,266 \$
1608	64	0,266 \$
2508	64	0,52 \$
3508	64	0,71 \$
5010	64	0,94 \$
7010	64	1,46 \$
9512	64	1,76 \$
12012	64	2,44 \$
15012	64	3,82 \$
18516	64	4,61 \$
24016	64	7,02 \$
EM16	64	0,266 \$
EM25	64	0,506 \$
EM35	64	0,663 \$
EM50	64	0,852 \$
EM70	64	1,42 \$
EM95	64	1,64 \$
EM120	64	2,37 \$
EM150	64	3,68 \$
EM185	64	4,86 \$
EM240	64	6,75 \$
SKPS-10-06	65	2,666 \$
1008	65	0,288 \$
1606	65	0,37 \$
1608	65	0,41 \$
SKPS-2506	65	0,694 \$
2508	65	0,694 \$
2510	65	0,694 \$
SKPS-35-06	65	0,947 \$
3508	65	0,947 \$
3510	65	1,028 \$
5008	65	1,44 \$
5010	65	1,44 \$
SKPS-50-12	65	1,44 \$
7008	65	1,97 \$
7010	65	1,85 \$
7012	65	1,85 \$
SKPS-95-08	65	2,37 \$
9510	65	2,37 \$
9512	65	2,37 \$
SKPS-120-10	65	3,315 \$
12012	65	3,315 \$
15010	65	4,93 \$
15012	65	4,93 \$
18510	65	6,09 \$
18512	65	6,09 \$
18516	65	6,09 \$
SKPS-240-10	65	8,33 \$
24012	65	8,33 \$
24016	65	8,33 \$
ELX-SKPB-16	66	3,18 \$

MALZEME KODU	SAYFA NO	B.FİYATI
ELX-SKPB-25	66	3,18 \$
SKPB35	66	3,18 \$
SKPB50	66	4,32 \$
SKPB70	66	4,32 \$
SKPB95	66	4,32 \$
SKPB120	66	7,15 \$
SKPB150	66	7,15 \$
SKPB185	66	11,5 \$
SKPB240	66	11,5 \$
2007	68	51,75 ₺
2010	68	60,95 ₺
2012	68	72,45 ₺
2015	68	81,10 ₺
2020	68	113 ₺
2022	68	125,5 ₺
2025	68	142,1 ₺
2030	68	162,1 ₺
1407	68	106,9 ₺
1410	68	119,6 ₺
1412	68	133,4 ₺
1415	68	172,5 ₺
1420	68	220,8 ₺
1422	68	238,5 ₺
1507	68	213,9 ₺
1510	68	227,7 ₺
1512	68	258,8 ₺
1520	68	414 ₺
1522	68	445 ₺
1525	68	517,5 ₺
3207	69	394,5 ₺
3210	69	575 ₺
3212	69	680,8 ₺
3215	69	845,5 ₺
3220	69	1127 ₺
3222	69	1145 ₺
3307	69	473,8 ₺
3310	69	689,8 ₺
3312	69	811,9 ₺
3315	69	1014 ₺
3320	69	1352 ₺
3322	69	1476 ₺
1004	70	9,78 ₺
1005	70	10,35 ₺
1006	70	13,80 ₺
1007	70	14,5 ₺
1009	70	16,10 ₺
1010	70	17,25 ₺
1012	70	21,20 ₺
1106	70	23 ₺
1107	70	25,50 ₺
1110	70	30,40 ₺
1112	70	32,90 ₺
1115	70	39,90 ₺
1120	70	51,95 ₺
1125	70	64,90 ₺
1130	70	90,80 ₺
221-412	70	0,627 €
221-413	70	0,767 €
221-415	70	1,254 €
221-482	70	1,127 €
221-483	70	1,347 €
221-485	70	1,897 €
221-612	70	1,254 €
221-613	70	1,504 €
221-615	70	2,502 €
221-682	70	1,718 €
221-683	70	2,004 €
221-685	70	2,956 €
2273-202	70	0,250 €
203	70	0,281 €
204	70	0,343 €
205	70	0,375 €
208	70	0,688 €
773106	70	0,767 €
773173	70	1,346 €
ELX2.5-2	71	0,119 \$
2.5-3	71	0,138 \$
2.5-4	71	0,158 \$
2.5-5	71	0,172 \$
2.5-6	71	0,226 \$
2.5-8	71	0,284 \$
ELX-412	71	0,238 \$
413	71	0,315 \$
414	71	0,397 \$
415	71	0,463 \$
ELX-KB 2.5X100	72	0,115 ₺
2.5-150	72	0,176 ₺
2.5-200	72	0,245 ₺
ELX-KB 3.6X150	72	0,268 ₺
3.6X200	72	0,352 ₺
3.6X250	72	0,420 ₺
3.6X300	72	0,536 ₺
3.6X370	72	0,675 ₺
ELX-KB 4.8X200	72	0,498 ₺
4.8X250	72	0,582 ₺
4.8X300	72	0,736 ₺
4.8X380	72	0,920 ₺
4.8X450	72	1,119 ₺
4.8X500	72	1,257 ₺
ELX-KB-8X300	72	1,364 ₺
8X380	72	1,610 ₺
8X450	72	1,863 ₺
8X550	72	2,514 ₺
8X650	72	3,618 ₺
8X750	72	3,97 ₺
ELX-KB-9X900	72	7,20 ₺
1515	68	316,3 ₺

Oel-max

2022 FİYAT KATALOĞU

İNDEKS	1-3
İÇİNDEKİLER...	4-5
OTOMATİK SİGORTA	6-9
KAÇAK AKIM RÖLELERİ	10
KONTAKTÖR UNMC SERİSİ	11
KONTAKTÖR D SERİSİ	12-13
YARDIMCI KONTAKTÖR BLOK	14
TERMİK RÖLELER	15
MİNİ KONTAKTÖR / MİNİ TERMİK RÖLE / SESSİZ KONTAKTÖR	
MOTOR KORUMA ŞALTERİ / DARBE AKIM ANAHTARI	16
BOŞ KUMANDA KUTULARI	17
KUTULU MONTAJLI ÜRÜNLER	18-19
KUMANDA KUTULARI	20-23
ASANSÖR KUMANDA SİSTEMİ VE KUYU BİLEŞENLERİ	24
BOY FOTSELİ	25
ASANSÖR PANOSU,EMC FİLTRE FRENLEME DİRENÇ	26
DEPREM SENSÖRÜ,DUMAN DEDEKTÖRÜ	27
ASANSÖR GRUBU MALZEMELERİ	28-37
AKÜLER,MIKNATISLAR,KÖPRÜ,DIYOT,30MM BUZZER,MİNİ ANAHTAR	38
24V GÜÇ KAYNAKLARI	39
LAY 5 PLATİK BUTON SERİSİ	40-41
LAY 5 METAL BUTON SERİSİ,JOYSTICK KONTROL,POTANSİYOMETRE	42-43



İÇİNDEKİLER...



ELX2M PLASTİK BUTON SERİSİ	44 - 46
LAY 5 YENİ PLASTİK BUTON SERİSİ	47 - 48
YEDEK KONTAK BLOK,SİRENLER,BUZZER VE LEDLİ SİNYAL LAMBA	49
LEDLİ VOLTMETRE,AMPERMETRE,VOLTMETRE - AMPERMETRE	50
LİMİT SWITCH	51 - 53
CSA METAL GÖVDELİ SWITCH	54
MINİ SWITCH	55 - 56
MİCRO SWITCH	57
İZOLELİ KABLO YÜKSÜKLERİ	58
İZOLELİ PABUÇLAR	59 - 60
TERMİNAL	61 - 63
KABLO PABUÇLARI	64 - 65
BİMETAL (AL-CU) SKP KABLO PABUCU	66
DAĞITIM ÜNİTESİ	68 - 69
TOPRAKLAMA KLEMENS, WAGO BUAT KLEMENSLERİ	70
GEÇMELİ BUAT KLEMENS,ÇOK AMAÇLI KLEMENS	71
PLASTİK KABLO BAĞLARI	72
T-BLOCK	73
VİNC KUMANDA BUTONLARI	74
AYAK PEDALLARI	75
HAREKETLİ COB LED SPOT	76
LED - AMPUL	77
T5 - BANT ARMATÜR	78
T5 - YATAY BANT ARMATÜR, NEMLİYER ETANJ ARMATÜR	79
İÇ MEKAN LED TRAFOLAR, 30W DIŞ MEKAN LED TRAFOSU	80 - 83

Otomatik Sigorta

1 Kutuplu Otomatik Sigortalar 6 kA



Teknik Özellikler

ÜRÜN KODU	TİPİ	ANMA AKIMI (A)	ANMA GERİLİMİ	AÇIKLAMA	K. ADEDİ	FİYAT
EMC-9-63	C	2 A	230/400 V	Otomatik Sigorta	240	3,60 \$
EMC-9-63	C	4 A	230/400 V	Otomatik Sigorta	240	3,60 \$
EMC-9-63	C	6 A	230/400 V	Otomatik Sigorta	240	3,13 \$
EMC-9-63	C	10 A	230/400 V	Otomatik Sigorta	240	3,13 \$
EMC-9-63	C	16 A	230/400 V	Otomatik Sigorta	240	3,13 \$
EMC-9-63	C	25 A	230/400 V	Otomatik Sigorta	240	3,13 \$
EMC-9-63	C	32 A	230/400 V	Otomatik Sigorta	240	3,23 \$
EMC-9-63	C	40 A	230/400 V	Otomatik Sigorta	240	3,23 \$
EMC-9-63	C	50 A	230/400 V	Otomatik Sigorta	240	3,60 \$
EMC-9-63	C	63 A	230/400 V	Otomatik Sigorta	240	3,60 \$

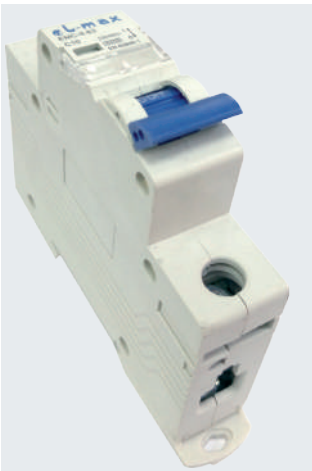

Otomatik Sigorta

3 Kutuplu Otomatik Sigortalar 6 kA



Teknik Özellikler

ÜRÜN KODU	TİPİ	ANMA AKIMI (A)	ANMA GERİLİMİ	AÇIKLAMA	K. ADEDİ	FİYAT
EMC 3-9-63	C	10 A	400 V	Otomatik Sigorta	80	10,56 \$
EMC 3-9-63	C	16 A	400 V	Otomatik Sigorta	80	10,56 \$
EMC 3-9-63	C	20 A	400 V	Otomatik Sigorta	80	10,56 \$
EMC 3-9-63	C	25 A	400 V	Otomatik Sigorta	80	10,56 \$
EMC 3-9-63	C	32 A	400 V	Otomatik Sigorta	80	11,66 \$
EMC 3-9-63	C	40 A	400 V	Otomatik Sigorta	80	11,66 \$
EMC 3-9-63	C	50 A	400 V	Otomatik Sigorta	80	13,87 \$
EMC 3-9-63	C	63 A	400 V	Otomatik Sigorta	80	13,87 \$



Otomatik Sigorta

3 Kutuplu Otomatik Sigortalar 10 kA



Teknik Özellikler

ÜRÜN KODU	TİPİ	ANMA AKIMI (A)	ANMA GERİLİMİ	AÇIKLAMA	K. ADEDİ	FİYAT
EMC 3-9-63	C	80 A	400 V	Otomatik Sigorta	60	42,00 \$
EMC 3-9-63	C	100 A	400 V	Otomatik Sigorta	60	44,00 \$
EMC 3-9-63	C	125 A	400 V	Otomatik Sigorta	60	46,00 \$



Otomatik Sigorta

4 Kutuplu Otomatik Sigortalar 6 kA

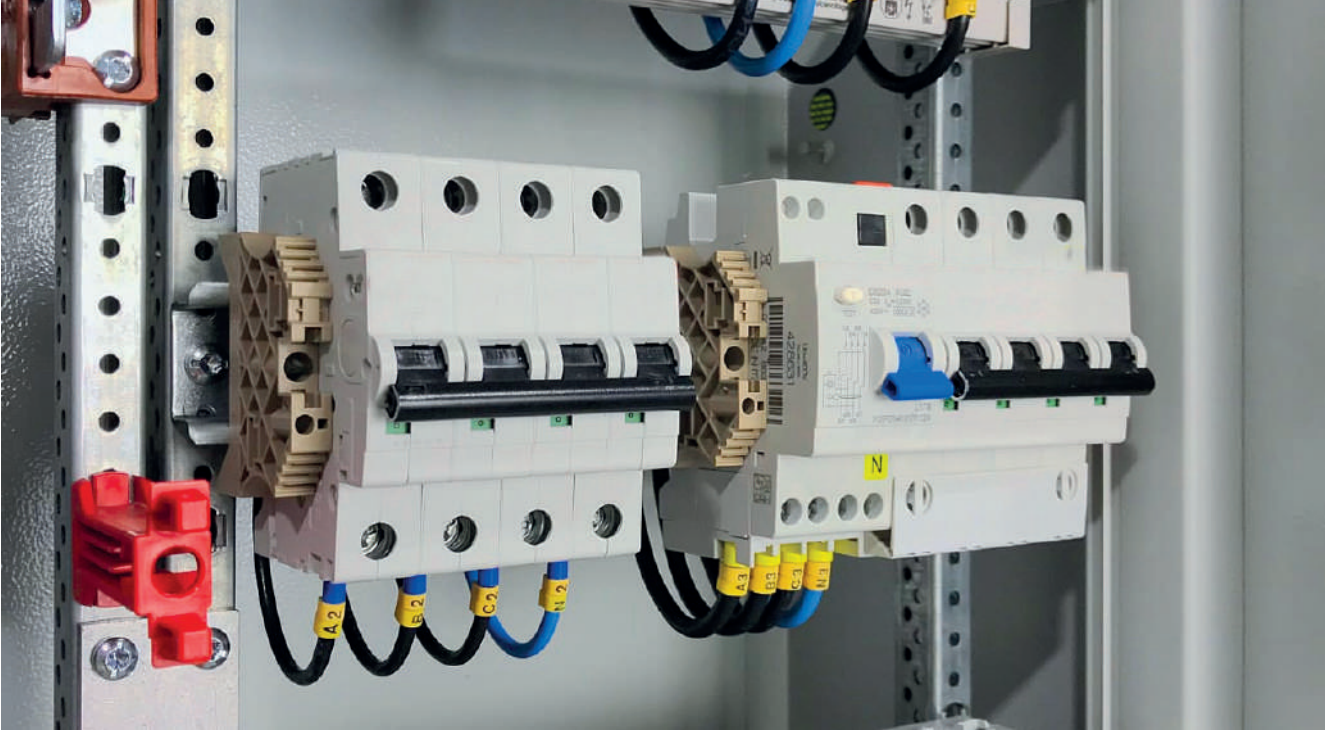

Teknik Özellikler

ÜRÜN KODU	TİPİ	ANMA AKIMI (A)	ANMA GERİLİMİ	AÇIKLAMA	K. ADEDİ	FİYAT
EMC 4-9-63	C	16 A	400 V	Otomatik Sigorta	60	15,72 \$
EMC 4-9-63	C	25 A	400 V	Otomatik Sigorta	60	15,72 \$
EMC 4-9-63	C	32 A	400 V	Otomatik Sigorta	60	16,20 \$
EMC 4-9-63	C	40 A	400 V	Otomatik Sigorta	60	16,20 \$
EMC 4-9-63	C	50 A	400 V	Otomatik Sigorta	60	18,00 \$
EMC 4-9-63	C	63 A	400 V	Otomatik Sigorta	60	18,00 \$



Kaçak Akım Röleleri



2 Kutuplu Kaçak Akım Rölesi 6 kA



Teknik Özellikler

ÜRÜN KODU	TİPİ	ANMA AKIMI (A)	ANMA GERİLİMİ	AÇIKLAMA	K. ADEDİ	FİYAT
ERB-2-25	30 mA	25 A	230 V	Kaçak Akım Rölesi	100	22,56 \$
ERB-2-25	300 mA	25 A	230 V	Kaçak Akım Rölesi	100	22,56 \$
ERB-2-32	30 mA	32 A	230 V	Kaçak Akım Rölesi	100	22,56 \$
ERB-2-32	300 mA	32 A	230 V	Kaçak Akım Rölesi	100	22,56 \$
ERB-2-40	30 mA	40 A	230 V	Kaçak Akım Rölesi	100	22,56 \$
ERB-2-40	300 mA	40 A	230 V	Kaçak Akım Rölesi	100	22,56 \$

4 Kutuplu Kaçak Akım Rölesi 6 kA



Teknik Özellikler

ÜRÜN KODU	TİPİ	ANMA AKIMI (A)	ANMA GERİLİMİ	AÇIKLAMA	K. ADEDİ	FİYAT
ERB-4-25	30 mA	25 A	230/400 V	Kaçak Akım Rölesi	50	31,38 \$
ERB-4-25	300 mA	25 A	230/400 V	Kaçak Akım Rölesi	50	31,38 \$
ERB-4-32	30 mA	32 A	230/400 V	Kaçak Akım Rölesi	50	31,38 \$
ERB-4-32	300 mA	32 A	230/400 V	Kaçak Akım Rölesi	50	31,38 \$
ERB-4-40	30 mA	40 A	230/400 V	Kaçak Akım Rölesi	50	31,38 \$
ERB-4-40	300 mA	40 A	230/400 V	Kaçak Akım Rölesi	50	31,38 \$
ERB-4-63	30 mA	63 A	230/400 V	Kaçak Akım Rölesi	50	31,38 \$
ERB-4-63	300 mA	63 A	230/400 V	Kaçak Akım Rölesi	50	31,38 \$

Kontaktör

3 Fazlı Kontaktör UNMC Serisi



Teknik Özellikler

ÜRÜN KODU	ANMA AKIMI (A)	ANMA GÜCÜ (kW) 50/60Hz	YARDIMCI KONTAK	K. ADEDİ	FİYAT
UNMC-12	12 A	5,5 kW	1NO+1NC	50	14,60 \$
UNMC-18	18 A	7,5 kW	1NO+1NC	50	20,00 \$
UNMC-22	22 A	11 kW	1NO+1NC	50	20,60 \$
UNMC-32	32 A	15 kW	2NO+2NC	40	32,75 \$
UNMC-40	40 A	18,5 kW	2NO+2NC	40	33,75 \$
UNMC-65	65 A	30 kW	2NO+2NC	20	58,00 \$
UNMC-85	85 A	45 kW	2NO+2NC	20	88,00 \$

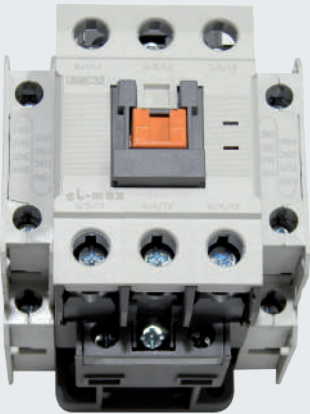

Kontaktör

3 Fazlı Kontaktör ELX-D Serisi

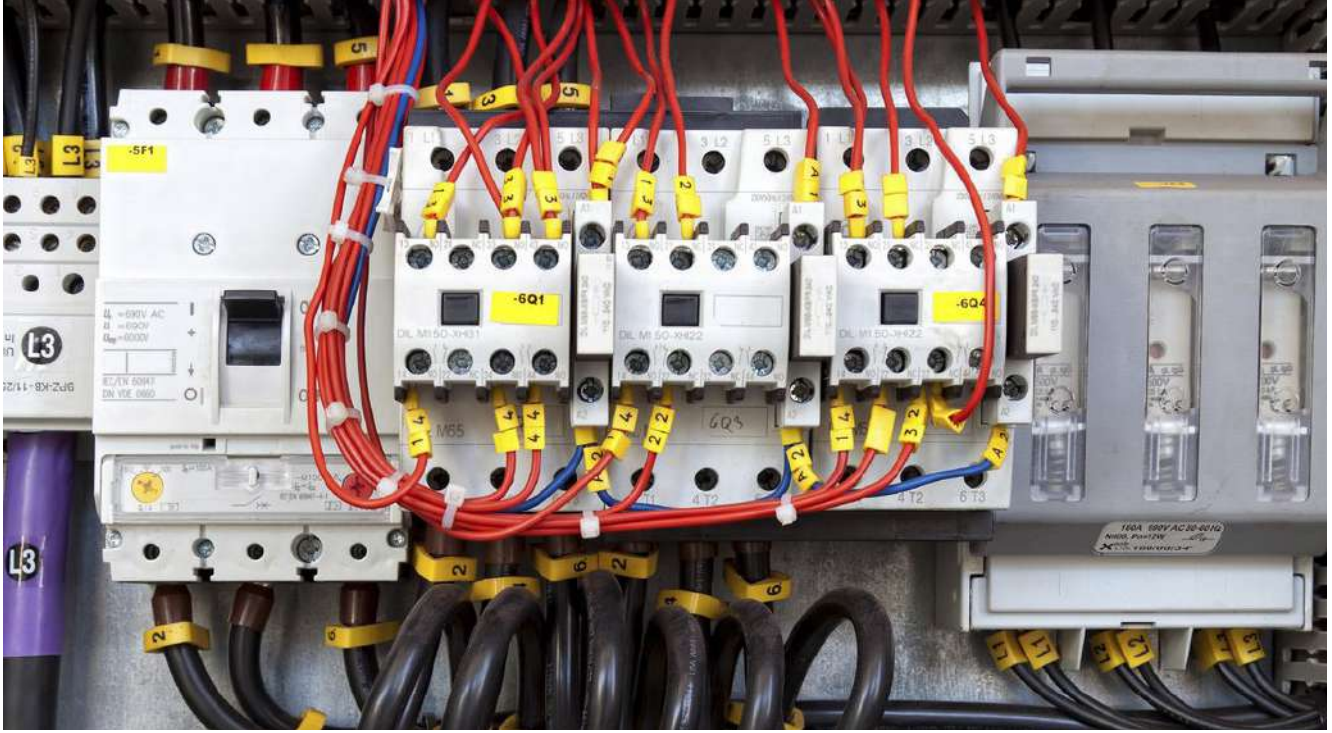

Teknik Özellikler

ÜRÜN KODU	ANMA AKIMI (A)	ANMA GÜCÜ (kW) 50/60Hz	YARDIMCI KONTAK	K. ADEDİ	FİYAT
ELX-D0910	9 A	4 kW	1NO	50	11,85 \$
ELX-D0901	9 A	4 kW	1NC	50	11,85 \$
ELX-D1210	12 A	5,5 kW	1NO	50	12,15 \$
ELX-D1201	12 A	5,5 kW	1NC	50	12,15 \$
ELX-D1810	18 A	7,5 kW	1NO	50	14,35 \$
ELX-D1801	18 A	7,5 kW	1NC	50	14,35 \$
ELX-D2510	25 A	11 kW	1NO	50	20,30 \$
ELX-D2501	25 A	11 kW	1NC	50	20,30 \$
ELX-D3210	32 A	15 kW	1NO	50	26,80 \$

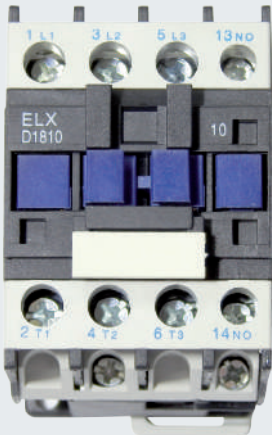

Kontaktör

3 Fazlı Kontaktör **ELX-D Serisi**



Teknik Özellikler

ÜRÜN KODU	ANMA AKIMI (A)	ANMA GÜCÜ (kW) 50/60Hz	K. ADEDİ	FİYAT
ELX-D115	115 A	55 kW	4	169,00 \$
ELX-D150	150 A	75 kW	4	180,00 \$
ELX-D170	170 A	90 kW	4	244,00 \$

Yardımcı Kontak Bloğu



Teknik Özellikler

ÜRÜN KODU	BİRLİKTE KULLANILDIĞI KONTAKTÖR	YARDIMCI KONTAK	MONTAJ ŞEKLİ	FİYAT
LAD-8N11	ELX-D115 - ELX-D170	1NO+1NC	YAN	10,60 \$

Yardımcı Kontak Blokları



UNMC Serisi Yardımcı Kontak Bloğu



Teknik Özellikler

ÜRÜN KODU	BİRLİKTE KULLANILDIĞI KONTAKTÖR	YARDIMCI KONTAK	MONTAJ ŞEKLİ	FİYAT
AU-2	UNMC-9-UNMC-40	1NO+1NC	ÜST	3,76 \$
AU-4	UNMC-9-UNMC-40	2NO+2NC	ÜST	6,25 \$

ELX-D Serisi Yardımcı Kontak Bloğu



Teknik Özellikler

ÜRÜN KODU	BİRLİKTE KULLANILDIĞI KONTAKTÖR	YARDIMCI KONTAK	MONTAJ ŞEKLİ	FİYAT
ELXDN11	ELX-D0910-ELX-D3210	1NO+1NC	ÜST	3,75 \$
ELXDN22	ELX-D0910-ELX-D3210	2NO+2NC	ÜST	6,25 \$

Termik Röleler

UNMR Serisi Termik Röle

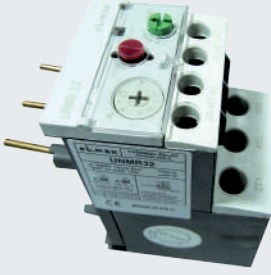

Teknik Özellikler

ÜRÜN KODU	ANMA AKIMI (A)	TERMİK AYAR SAHASI	K. ADEDİ	FİYAT
UNMR-32-10	10 A	7-10 A	50	14,30 \$
UNMR-32-13	13 A	9-13 A	50	14,30 \$
UNMR-32-18	18 A	13-18 A	20	14,30 \$
UNMR-32-25	25 A	17-25 A	20	14,30 \$
UNMR-32-32	32 A	23-32 A	20	17,20 \$
UNMR-85-65	65 A	45-65 A	20	24,30 \$
UNMR-85-85	85 A	63-85 A	20	24,30 \$

ELX-D Serisi Termik Röle



Teknik Özellikler

ÜRÜN KODU	ANMA AKIMI (A)	TERMİK AYAR SAHASI	K. ADEDİ	FİYAT
UNTR1-D13-2,5	2,5 A	1,6-2,5 A	50	11,88 \$
UNTR1-D13-4	4 A	2,5-4 A	50	11,88 \$
UNTR1-D13-6	6 A	4-6 A	50	11,88 \$
UNTR1-D13-8	8 A	5-8 A	50	11,88 \$
UNTR1-D13-10	10 A	7-10 A	50	11,88 \$
UNTR1-D13-13	13 A	9-13 A	50	11,88 \$
UNTR1-D13-18	18 A	12-18 A	50	11,88 \$
UNTR1-D13-25	25 A	17-25 A	50	11,88 \$
UNTR1-D13-32	32 A	23-32 A	50	11,88 \$

Raya Montaj Termik Röle



Teknik Özellikler

ÜRÜN KODU	ANMA AKIMI (A)	TERMİK AYAR SAHASI	K. ADEDİ	FİYAT
UNSRI-D59-4	4 A	2,5-4 A	50	16,88 \$
UNSRI-D59-6,3	6,3 A	4-6,3 A	50	16,88 \$
UNSRI-D59-10	10 A	6,3-10 A	50	16,88 \$
UNSRI-D59-16	16 A	10-16 A	50	16,88 \$
UNSRI-D59-25	25 A	16-25 A	50	20,00 \$
UNSRI-D59-40	40 A	25-40 A	50	20,00 \$
UNSRI-D59-57	57 A	40-57 A	50	20,00 \$
UNSRI-D59-63	63 A	57-63 A	50	20,00 \$

Mini Kontaktör / Mini Termik Röle / Sessiz Kontaktör Motor Koruma Şalteri / Darbe Akım Anahtarı

3 Fazlı Mini Kontaktör



Teknik Özellikler

ÜRÜN KODU	ANMA AKIMI AC-3 (A)	ANMA GÜCÜ (kW) 50/60Hz	AC1 (A)	YARDIMCI KONTAK	K. ADEDİ	FİYAT
MK-910	9 A	4 kW	16 A	1NO	100	13,75 \$
MK-901	9 A	4 kW	16 A	1NC	100	13,75 \$

Mini Kontaktör İçin Termik Röle



Teknik Özellikler

ÜRÜN KODU	TERMİK AYAR SAHASI (A)	ANMA AKIMI (A)	K. ADEDİ	FİYAT
UNTR-MK-6	4-6 A	6 A	100	11,42 \$

Sessiz Kontaktör (Aydınlatma Kontaktörü)



Teknik Özellikler

ÜRÜN KODU	ANMA AKIMI AC-3 (A)	KUTUP	YARDIMCI KONTAK	K. ADEDİ	FİYAT
ELX-2P-25A	25 A	2	2NO	100	14,38 \$
ELX-2P-40A	40 A	2	2NO	100	25,00 \$
ELX-4P-40A	40 A	4	4NO	100	35,00 \$

Motor Koruma Şalteri



Teknik Özellikler

ÜRÜN KODU	ANMA AKIMI (A)	TERMİK AYAR (A)	AÇIKLAMA	K. ADEDİ	FİYAT
EMK-R-4	4.0 A	2,5-4 A	Motor Koruma Şalteri	50	31,88 \$
EMK-R-6,3	6.3 A	4-6,3 A	Motor Koruma Şalteri	50	31,88 \$
EMK-R-10	10 A	6-10 A	Motor Koruma Şalteri	50	31,88 \$
EMK-R-14	14 A	9-14 A	Motor Koruma Şalteri	50	31,88 \$
EMK-R-18	18 A	13-18 A	Motor Koruma Şalteri	50	31,88 \$
EMK-R-23	23 A	17-23 A	Motor Koruma Şalteri	50	31,88 \$
EMK-R-25	25 A	20-25 A	Motor Koruma Şalteri	50	31,88 \$
EMK-R-32	32A	24-32 A	Motor Koruma Şalteri	50	31,88 \$

Darbe Akım Anahtarı



Teknik Özellikler

ÜRÜN KODU	ANMA AKIMI	K. ADEDİ	FİYAT
EDA-16	16 A	240	16,46 \$

Boş Kumanda Kutuları

ELX-BOX-1

1'li Boş Buton Kutusu

FİYAT: 1,12 \$

ÖLÇÜLER		
U	G	D
70	70	60



ELX-BOX-1K

1'li Boş Buton Kutusu Korumalı

FİYAT: 1,85 \$

ÖLÇÜLER		
U	G	D
70	70	60



Boş Buton Kutuları
(IP44)



Teknik Özellikler

ÜRÜN KODU	AÇIKLAMA	K. ADEDİ	FİYAT
LAY5 (DB2) Box1	1'li Boş Kumanda Kutusu	100	1,12 \$
LAY5 (DB2) Box2	2'li Boş Kumanda Kutusu	100	2,25 \$
LAY5 (DB2) Box3	3'lü Boş Kumanda Kutusu	75	2,75 \$
LAY5 (DB2) Box4	4'lü Boş Kumanda Kutusu	50	3,30 \$
LAY5 (DB2) Box5	5'li Boş Kumanda Kutusu	50	4,18 \$
LAY5 (DB2) Box6	6'li Boş Kumanda Kutusu	25	4,50 \$
LAY5 (DB2) Box7	7'li Boş Kumanda Kutusu	25	4,83 \$

Kutulu Montajlı Ürünler

ELX-BX1-AS

Acil Stop
40 mm 1NC Kalıcı Kutu

FİYAT: 3,37 \$

ÖLÇÜLER		
U	G	D
70	70	60



ELX-BX1-ASK

Acil Stop 40 mm 1NC
Kalıcı Korumalı Kutu

FİYAT: 3,50 \$

ÖLÇÜLER		
U	G	D
70	70	60



ELX-ALM-1

Kutulu Tekli Alarm Butonu

FİYAT: 3,00 \$

ÖLÇÜLER		
U	G	D
70	70	60



ELX-K

Buton Koruma Kapağı

FİYAT: 0,80 \$

ÖLÇÜLER		
U	G	D
54	47	35



Kutulu Montajlı Ürünler

ELX-PAS-1

1'li Alarm Seti

FİYAT: 8,00 \$

ÖLÇÜLER		
U	G	D
120	70	60

- * 9 V Pili 120db
- * 6 Ton Siren



ELX-BYP-B-24 VDC

Bypass Flaşör Sesli İkaz
Bypass Buzzer

FİYAT: 4,05 \$

ÖLÇÜLER		
U	G	D
70	70	60



ELX-KDRR-EG61

Kuyu Dışından
Revizyon Reset Anahtar

FİYAT: 4,85 \$

ÖLÇÜLER		
U	G	D
70	70	60



ELX-KAB-EA21

Kuyu Aydınlatma Butonu

FİYAT: 3,46 \$

ÖLÇÜLER		
U	G	D
70	70	60



Kumanda Kutuları

ELX-BX5-4

4'lü Revizyon Kutusu

FİYAT: 10,30 \$

ÖLÇÜLER		
U	G	D
190	65	70



ELX-BX5-5

5'li Revizyon Kutusu
Ortası Mavi

FİYAT: 11,20 \$

ÖLÇÜLER		
U	G	D
190	65	70



ELX-BX6-5P

6'lı Revizyon Kutusu Ortası Boş,
Alarm, Buzzer ve Prizli

FİYAT: 13,50 \$

ÖLÇÜLER		
U	G	D
300	80	70



ELX-BX6-6

6'lı Revizyon Kutusu

FİYAT: 15,00 \$

ÖLÇÜLER		
U	G	D
300	80	70



* ÜRÜNLERİMİZ MIKNATIS TABANLIDIR.

Kumanda Kutuları

ELX-ELP-RK

Prizli Revizyon Kutusu

FİYAT: 10 \$

ÖLÇÜLER		
U	G	D
170	80	70



* ÜRÜNLERİMİZ MIKNATIS TABANLIDIR.

ELX-EL3BYLS-RK

3 Kademe By Pass'lı
Ledli Sinyalli Revizyon Kutusu

FİYAT: 17,00 \$

ÖLÇÜLER		
U	G	D
170	80	70



ELX-EL3B-PLS-RK

3 Kademe By Pass'lı Prizli,
Ledli Sinyalli Revizyon Kutusu

FİYAT: 20,50 \$

ÖLÇÜLER		
U	G	D
170	80	70



ELX-ELK5

5'li Revizyon Kutusu
İki Korumalı

FİYAT: 13,00 \$

ÖLÇÜLER		
U	G	D
170	80	70



* ÜRÜNLERİMİZ MIKNATIS TABANLIDIR.

ELX-EL3BY-RK

3 Kademe By Paslı
Kuyu Aydınlatma Kutusu

FİYAT SORUNUZ

ÖLÇÜLER		
U	G	D
130	95	75



Kumanda Kutuları

ELX-ELK4

4'lü Revizyon Kutusu
İki Korumalı

FİYAT: 11,25 \$

ÖLÇÜLER		
U	G	D
170	80	70

* ÜRÜNÜMÜZ
MIKNATIS
TABANLIDIR.



ELX-BX-7K

7'li El Kumanda Kuyu Dibi

FİYAT: 17,00 \$

ÖLÇÜLER		
U	G	D
300	70	70



* ÜRÜNÜMÜZ MIKNATIS TABANLIDIR.

ELX-BX-7P

7'li El Kumanda
Prizli, Buzzerli Revizyon

FİYAT: 18,50 \$

ÖLÇÜLER		
U	G	D
300	70	70



* ÜRÜNÜMÜZ MIKNATIS TABANLIDIR.

ELX-KY-10

10'lu Kuyu Dibi Kutusu

FİYAT: 21,10 \$

ÖLÇÜLER		
U	G	D
235	130	110



Kumanda Kutuları

ELX-BX6-6N

6'lı Revizyon Kutusu
Yeni Tip

FİYAT: 17,00 \$

ÖLÇÜLER		
U	G	D
200	70	70



ELX-AKDMİ-7

Asansör Kuyu Dibi Kutusu

FİYAT: 21,10 \$

ÖLÇÜLER		
U	G	D
200	130	100



ELX-2MSK-K5

5'li Revizyon Kutusu
2M Silikon Kılıflı Buton, 2 Korumalı

YENİ ÜRÜN

FİYAT: Sorunuz

ÖLÇÜLER		
U	G	D
170	80	70



Boy Fotoseli

EL-MAX

Ultimate Boy Fotoseli

- 192 Işın
- Çapraz Tarama
- Dayanıklı Kablo
- Soketli Kablo Bağlantısı
- Uluslararası Standartlara Uygunluk
- **64 Adet Kızıl Ötesi Led**
64 pieces infrared led
- **Çapraz tarama ile 192 ışın**
192 beams with the cross scan
- **Dayanıklı malzeme soketli kablolar**
Durable components, cables with sockets
- **10 mm. - 1950 mm. arası algılama boyutu**
Sensation dimension between 10 mm. - 1950 mm.
- **4000 mm. den etkin algı özelliği**
Sensation distance to 4000 mm.

PANORAMİK ASANSÖRLERDE
%100 ÇALIŞMA
PERFORMANSI



- **-15 °C + 55 °C sıcaklık arası çalışabilme**
Working between -15 °C, + 55 °C
- **AC220V- DC24V1A Kontrol merkezi**
AC220V - DC24V1A Control unit
- **1995 mm. boy x 11,5 mm. genişlik x 24 mm. derinlik**
1995 mm. height x 11,5 mm. width x 24 mm. depth
- **Uluslararası standartlara uygunluk**
International standards available

ÖRNEK MONTAJ UYGULAMALARI

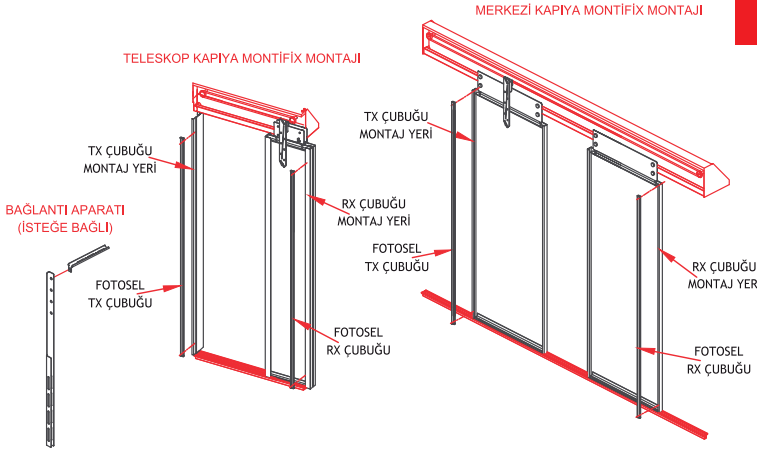

EL-MAX BOY FOTOSELİ'nin montajı esnasında dikkat edilmesi gereken hususlar aşağıda belirtilmiştir; Fotosel montajında bağlantı aparatı kullanamıyorsanız, aşağıdaki kapı modellerinde gösterildiği gibi FOTOSEL RX ve TX çubuklarını, TX ve RX çubuğu montaj yeri olarak gösterilen kapının arka kısmına ilgili yerlerinden vida ile monte ediniz.

MONTAJ ESNASINDA

- Alıcı ve verici çubukları, beraberinde verilen civatalar ve diğer bağlantı elemanları ile montaj deliklerinden kabine veya kabin kapılarına monte ediniz.
- Alıcı ve verici çubuklarının aynı seviyede olmalarına dikkat ediniz. Paralellik toleranslar dahilinde sağlanmadığı takdirde ürün hata verecektir.
- Power Ünitesini kabin üzerinde uygun bir yere (Yer varsa revizyon kutusu içerisine) monte ediniz.
- Power Ünitesi enerji bağlantılarını bağlantı şemasına uygun şekilde yapınız.
- Alıcı ve verici çubukları üzerinden gelen kabloların güç kaynağındaki uygun soketlere bağlayın ve kabloların gerilmeden rahat hareket ettiğini kontrol ediniz.
- Daha sonra enerji beslemesini açtığınızda Power Ünitesi üzerindeki yeşil ışığın yandığını göreceksiniz. Sonrasında ışınlarda bir kesinti olduğunda Power Ünitesi üzerindeki kırmızı ışığın yandığını göreceksiniz.

UYARI

EL-MAX BOY FOTOSELİ'nin kablolarının kesilmesi, ezilmesi, alüminyum çubuklarının (TX ve RX çubukları) darbeye maruz kalması, LED yollarının koparılması, çalışma gerilimi .. dışında bir gerilime maruz kalması, PCB bakır yollarının kesilmesi, Power Ünitesi veya çubuklar içerisine sıvı teması gibi kullanıcı kaynaklı durumlarda garanti dışıdır.

DİKKAT

Konya Elmak Elektrik, bu kılavuzdaki güvenlik bilgilendirmelerine ve emniyet kurallarına uymama sonucu ortaya çıkabilecek olumsuz durumlardan, zararlardan veya sakatlanmalardan sorumlu değildir. Çalışma koşullarının veya şantiye şartlarının gerektirdiği farklılıklardan dolayı ilave detay bilgilendirmeleri gerekli olabilir. Üretici firma olan Konya Elmak Elektrik'in bu süreçlerde sorumluluğu olmadığından yerel sağlık, emniyet ve iş güvenliği kurallarına uymak asansör montajı yapan firmanın sorumluluğundadır.

Asansör Kumanda Sistemi ve Kuyu Bileşenleri

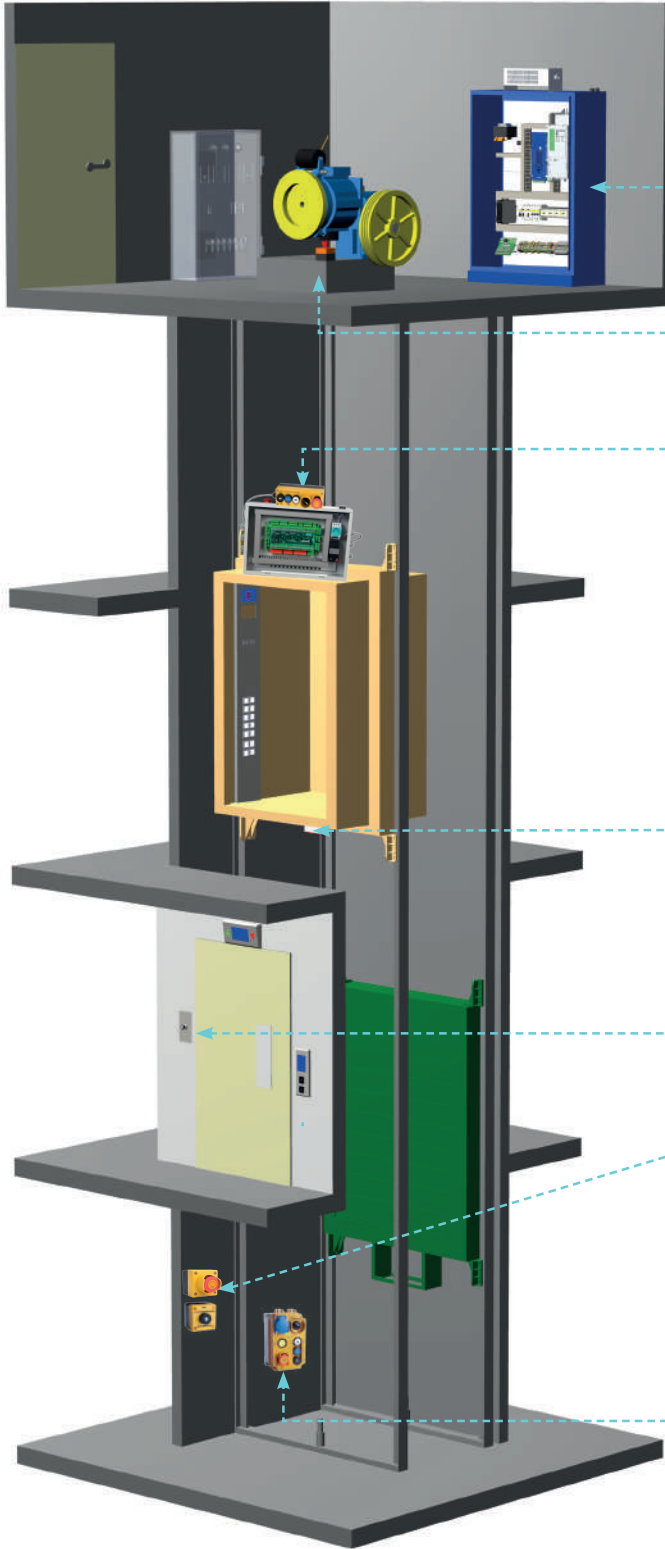

4'lü El Terminali
ELX-BX5-4

Kumanda Panosu
Control Panel



Durdurma Anahtarı
Emergency Stop



Kabin Üzeri Revizyon Seti
Car-Roof Inspection Box

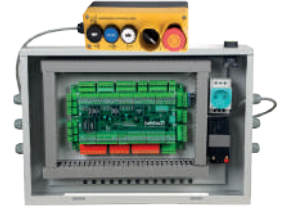

5'li El Terminali
ELX-BX5-5

Bypass Tertibat Sireni
Bypass Siren



Reset Anahtarı
Electrical Reset Switch



Durdurma ve Kuyu Ayd. Butonu
Emergency Stop and Shaft
Lighting Button Box



Muayene Kumanda İstasyonu
Inspection Control Station
(Pit)



Asansör Panosu EMC Filtre

ELX-ASP

Asansör Panosu

- * Asansör Panosu EL-MAX
- * Asansör Panosu OAG
- * Asansör Panosu HİMEL
- * Asansör Panosu GENERAL
- * Asansör Panosu MAKEL
- * Asansör Panosu SCHNEIDER

**PANOLARIMIZ
6x40 PAKO
ŞALTERLİDİR.**

FİYAT SORUNUZ



ELX-30-EMC

EMC Filtre 30 Amper

FİYAT SORUNUZ



Çalışma Voltajı : 400V
Çalışma Frekansı : 0 - 50 Hz
Çalışma Akımı : 30A
Çalışma Sıcaklığı : -20 C / +80 C

ELX-FD

Frenleme Direnci

FİYAT SORUNUZ

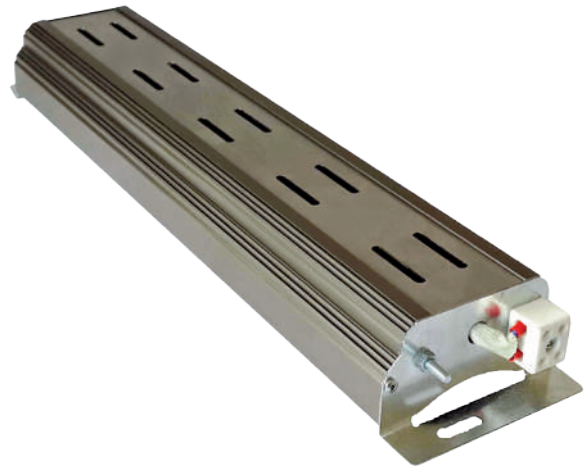

Deprem Sensörü Duman Dedektörü

ELX-DS

Deprem Sensörü

FİYAT SORUNUZ



ELX-DD-12

Duman Dedektörü
12 Volt DC

FİYAT SORUNUZ



ELX-DD-24

Duman Dedektörü
24 Volt DC

FİYAT SORUNUZ



Asansör Grubu Malzemeleri



ELXF-120-24 Metal Kare Fan



ÜRÜN KODU	ELXF-120-24
AKIM	24 V AC
AÇIKLAMA	120x120mm Metal Kare Fan
KUTU ADEDİ	40 Adet

ELXF-120-220 Metal Kare Fan



ÜRÜN KODU	ELXF-120-220
AKIM	220 V AC
AÇIKLAMA	120x120mm Metal Kare Fan
KUTU ADEDİ	40 Adet

ELXF-172-220 Metal Kare Fan



ÜRÜN KODU	ELXF-172-220
AKIM	220 V AC
AÇIKLAMA	172x150mm Metal Kare Fan
KUTU ADEDİ	10 Adet

FİYAT SORUNUZ

Turbo Fanlar

Teknik Özellikler

ÜRÜN KODU	BESLEME	AKIM	GÜÇ	HIZ	KAPASİTE
DMX-T180	220-240 VAC	0.14A	18W	1850	150 m3/h
DMX-T240	220-240 VAC	0.25A	26W	2450	170 m3/h
DMX-T300	220-240 VAC	0.27A	32W	2100	230 m3/h

Fiyat Sorunuz.

Gövdesi yüksek ısı uygulamaları için özel olarak ısıya dayanıklı yüksek kalite galvanize çelik saçdan, fanı alüminyumdan üretilmiştir. • Dikey Buzdolapları. • Hava Perdeleri. • Fırınlar. • Doğalgaz sobaları. • El kurutma cihazları. • Zemin seviye ısıtıcıları. • Isıtma-Soğutma amaçlı bütün endüstriyel uygulamalarda kullanılır.

Asansör Grubu Malzemeleri

ELX-LED-5-SNB

5W Hareketli Spot Armatür

FİYAT SORUNUZ



5 W Saten Nikel Gövde
Beyaz Işık, Hareketli Spot

ELX-LTFA

T5 Anahtarlı Led Bant Armatür **KABLOLU**

FİYAT SORUNUZ



AÇIKLAMA	FİYAT
6 W Anahtarlı Led Lamba	Fiyat Sorunuz
10 W Anahtarlı Led Lamba	Fiyat Sorunuz
12 W Anahtarlı Led Lamba	Fiyat Sorunuz
16 W Anahtarlı Led Lamba	Fiyat Sorunuz

ELX-LTFA

Ledli Yatay Bant Armatür

FİYAT SORUNUZ



AÇIKLAMA	FİYAT
18 W Yatay Led Lamba	Fiyat Sorunuz
36 W Yatay Led Lamba	Fiyat Sorunuz

ELX-LEA

Nemliyer Ledli Etanj Armatür

FİYAT SORUNUZ

IP 65
30.000 Saat Ömür
6500 K



AÇIKLAMA	FİYAT
18 w Etanj	Fiyat Sorunuz
36 w Etanj	Fiyat Sorunuz

Asansör Grubu Malzemeleri

NÜVE

FİYAT SORUNUZ



ELX-STA

Mono Stabil / Bi Stabil / Silver Mono Stabil

FİYAT SORUNUZ



- 1,5 mt. Kablolu
- Mono Stable
- Bi Stable

KLEMENS AKSESUAR

FİYAT SORUNUZ

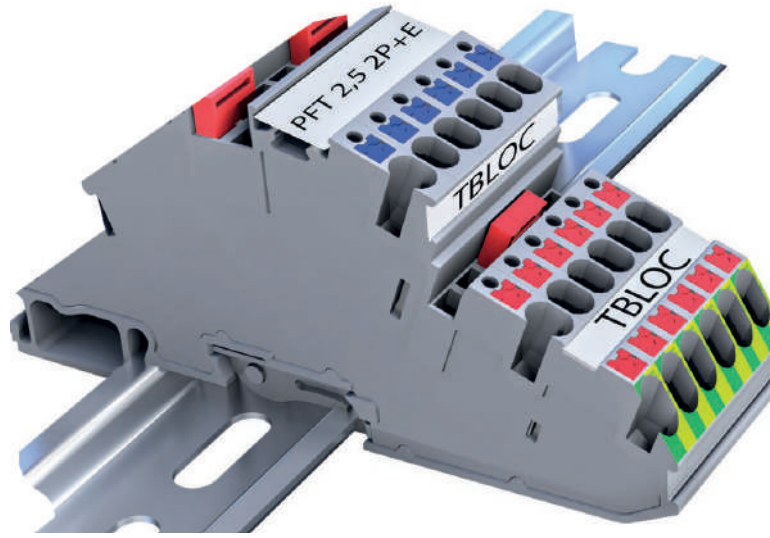

OTOMAT RAYI

Ray Taşıyıcı

FİYAT SORUNUZ

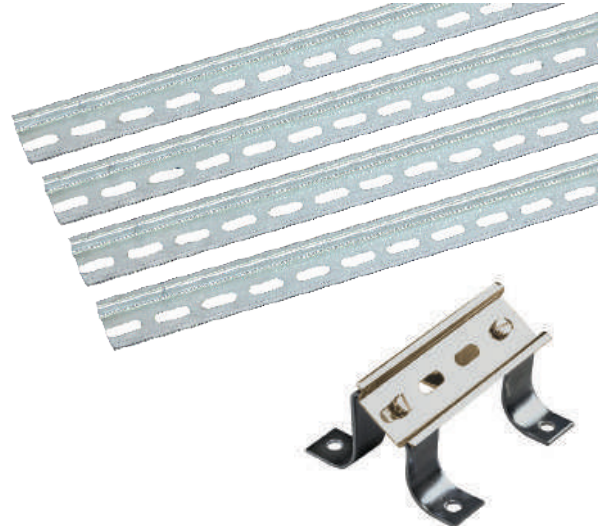

Asansör Grubu Malzemeleri

KABLOLARIMIZ BAKIRDIR



ELX-0.80NYA

0.80 NYA Kablo

FİYAT SORUNUZ



ELX-DT13

DT 13 Dijital Kablo - Telefon Kabloları

FİYAT SORUNUZ



Asansör Grubu Malzemeleri

RAYA Montaj Pano Prizi

FİYAT SORUNUZ



TRAFO Asansör Güç Trafosu

FİYAT SORUNUZ



3x25 Amper Makina Prizi

FİYAT SORUNUZ



1x16 Amper Pano Prizi

FİYAT SORUNUZ



Asansör Grubu Malzemeleri

ELX-PS

Pako Şalter

FİYAT SORUNUZ

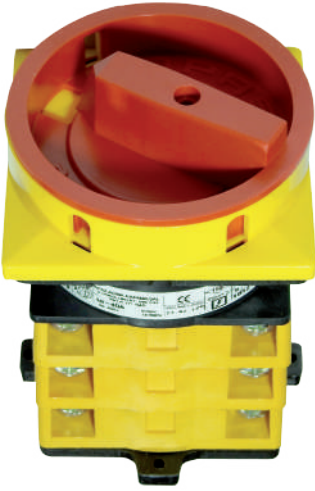

BY-PASS

Şalter

FİYAT SORUNUZ



NEMLİYER GRUBU

FİYAT SORUNUZ



ELX-BKA

Beta Kafesli Aplik

FİYAT SORUNUZ



ELX-LED

E-27 Led Ampul

FİYAT SORUNUZ



AÇIKLAMA
10 W E-27 Led Ampul

FİYAT
Fiyat Sorunuz

Asansör Grubu Malzemeleri

SEYYAR EL LAMBASI

FİYAT: SORUNUZ



PANO SİRALI

1-2-3-4 No

FİYAT: SORUNUZ



PLASTİK SİRAL

14-18 mm

FİYAT: SORUNUZ



KLEMENS

7 Delikli Topraklama Klemensi

FİYAT: SORUNUZ



Asansör Grubu Malzemeleri

KRC KARTI

FİYAT: SORUNUZ

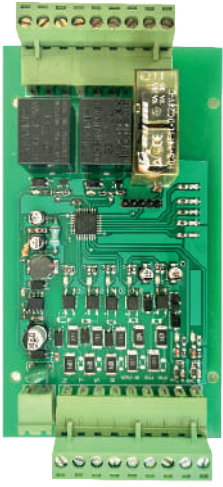

DİYOT KARTI

FİYAT: SORUNUZ



MH70 - MH80

Fırçalı Motor Kapı Kartı

FİYAT: SORUNUZ

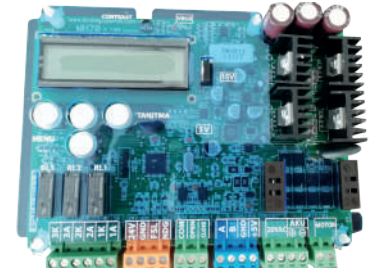

REVİZYON KARTI

Trafosuz

FİYAT: SORUNUZ

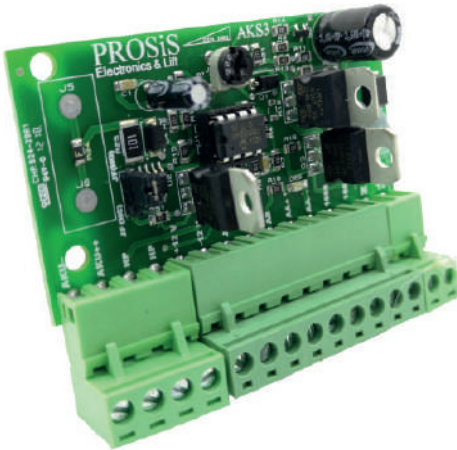

KLEMENS KARTI

Kuyu Dibi Muayene İstasyonu

FİYAT: SORUNUZ

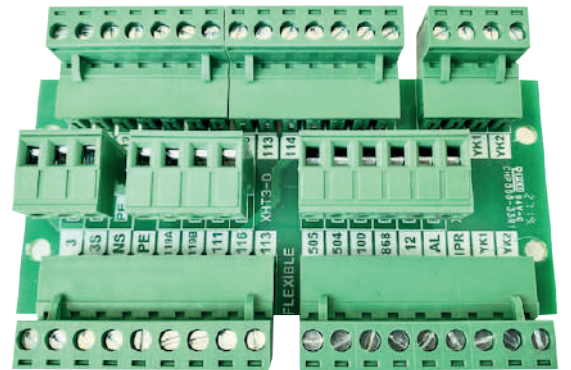

Haberleşme Sistemi

ÇİFT YÖNLÜ SESLİ HABERLEŞME SİSTEMİ



İTERKOM SİSTEMLERİ

TELEFON AHİZESİ



KARŞILIKLI GÖRÜŞME

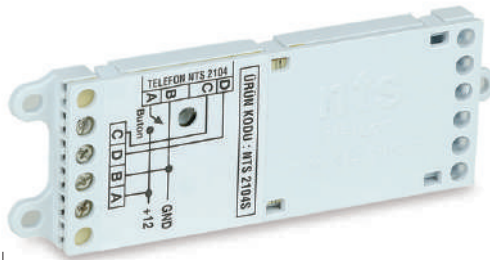

4 KABLO İLE BAĞLANTI



2 KABLO İLE BAĞLANTI

Kablo Kanalları

DELİKLİ KABLO KANALLARI

FİYAT: SORUNUZ

24 x 40 mm
25 x 60 mm
40 x 40 mm
40 x 60 mm
60 x 60 mm
60 x 80 mm

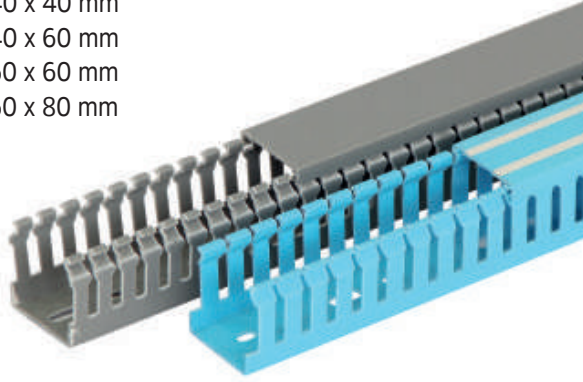

KAPALI KABLO KANALLARI

FİYAT: SORUNUZ

16 x 16 mm
25 x 16 mm
25 x 25 mm
40 x 60 mm
60 x 40 mm
10 x 40 mm
100 x 60 mm



SAÇ KABLO KANALLARI

FİYAT: SORUNUZ

50 x 40 mm
100 x 40 mm
100 x 60 mm



KANAL KROŞESİ

FİYAT: SORUNUZ

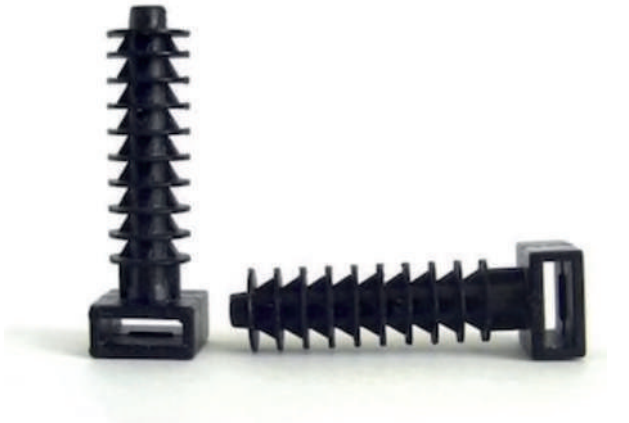

Buzzer - Aküler - Köprü Diyot Mıknatıs Işıklı Mini Anahtar

Ø 30mm Ses'li Buzzer (105 dB)



Teknik Özellikler

ÜRÜN KODU	RENK	VOLTAJ	K. ADEDİ	AÇIKLAMA	FİYAT
FM - 220AA 901AF	■ Siyah	110-220V. AC	20	Ø 30mm Tek Ses İkazlı	26,25 \$
FM - 220AA 907AF	■ Siyah	110-220V. AC	20	Ø 30mm Çift Ses İkazlı	30 \$
FM - 24AA 901AF	■ Siyah	12-48V. AC-DC	20	Ø 30mm Tek Ses İkazlı	26,25 \$
FM - 24AA 907AF	■ Siyah	12-48V. AC-DC	20	Ø 30mm Çift Ses İkazlı	30 \$

Not: Tek Ses İkazlılar Kesik Tonlu, Çift Ses İkazlar Kesik ve Sürekli Tonludur.

Mıknatıslar



Teknik Özellikler

ÜRÜN KODU	K. ADEDİ	AÇIKLAMA	FİYAT
22 x 7	1500	22 mm Çap, 7 mm Yükseklik Kırmızı Boyalı Yuvarlak Mıknatıs	0,14 \$
10 cm Şerit Mıknatıs	360	20 mm en, 8 mm Yükseklik, Şerit Mıknatıs	0,69 \$
30 cm Şerit Mıknatıs	120	20 mm en, 8 mm Yükseklik, Şerit Mıknatıs	2,08 \$

Aküler / AGM Kuru Tip Akü



Teknik Özellikler

ÜRÜN KODU	K. ADEDİ	AÇIKLAMA	FİYAT
EL 12 1.3	20	12V 1.3Ah/20hr	Sorunuz
EL 12 7	8	12V 7Ah/20hr	Sorunuz

Köprü Diyot



Teknik Özellikler

ÜRÜN KODU	AKIM	AÇIKLAMA	K. ADEDİ	FİYAT
KD-35	35 AMPER	Köprü Diyot	50	1,17 \$
KD-50	50 AMPER	Köprü Diyot	50	2,05 \$

Mini Anahtarlar

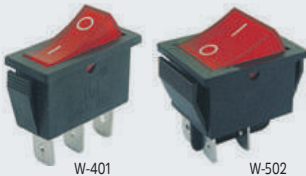

Teknik Özellikler

FİYAT SORUNUZ

ÜRÜN KODU	AYAK SAYISI	YÜK GERİLİMİ	AÇIKLAMA	FONKSİYON	ÖLÇÜ
W-401	3 Pin	6 A / 250 VAC	Işıklı Dar Tip	ON-OFF	28,5 x 10,5
W-502	4 Pin	6 A / 250 VAC	Işıklı Geniş Tip	ON-OFF	Işıklı Geniş Tip

24 V Güç Kaynakları

IP:20
24 V



15 W Güç Kaynağı

FİYAT: 9,25 \$

ÜRÜN KODU	ELX-TR-24-15
GÜÇ	15 W
AÇIKLAMA	Güç Kaynağı
AKIM	0.6 A
KUTU ADEDİ	400 Adet

25 W Güç Kaynağı

FİYAT: 12,50 \$

ÜRÜN KODU	ELX-TR-24-25
GÜÇ	25 W
AÇIKLAMA	Güç Kaynağı
AKIM	1.0 A
KUTU ADEDİ	200 Adet

60 W Güç Kaynağı

FİYAT: 17,22 \$

ÜRÜN KODU	ELX-TR-24-60
GÜÇ	60 W
AÇIKLAMA	Güç Kaynağı
AKIM	2.5 A
KUTU ADEDİ	100 Adet

100 W Güç Kaynağı

FİYAT: 22,5 \$

ÜRÜN KODU	ELX-TR-24-100
GÜÇ	100 W
AÇIKLAMA	Güç Kaynağı
AKIM	4.0 A
KUTU ADEDİ	50 Adet

120 W Güç Kaynağı

FİYAT: 23,40 \$

ÜRÜN KODU	ELX-TR-24-120
GÜÇ	120 W
AÇIKLAMA	Güç Kaynağı
AKIM	5 A
KUTU ADEDİ	50 Adet

150 W Güç Kaynağı

FİYAT: 29,5 \$

ÜRÜN KODU	ELX-TR-24-150
GÜÇ	150 W
AÇIKLAMA	Güç Kaynağı
AKIM	6.25 A
KUTU ADEDİ	50 Adet

200 W Güç Kaynağı

FİYAT: 33,9 \$

ÜRÜN KODU	ELX-TR-24-200
GÜÇ	200 W
AÇIKLAMA	Güç Kaynağı
AKIM	8.5 A
KUTU ADEDİ	50 Adet

250 W Güç Kaynağı

FİYAT: 38,50 \$

ÜRÜN KODU	ELX-TR-24-250
GÜÇ	250 W
AÇIKLAMA	Güç Kaynağı
AKIM	10 A
KUTU ADEDİ	20 Adet

350 W Güç Kaynağı

FİYAT: 45,00 \$

ÜRÜN KODU	ELX-TR-24-350
GÜÇ	350 W
AÇIKLAMA	Güç Kaynağı
AKIM	15 A
KUTU ADEDİ	20 Adet

400 W Güç Kaynağı

FİYAT: 49,00 \$

ÜRÜN KODU	ELX-TR-24-400
GÜÇ	400 W
AÇIKLAMA	Güç Kaynağı
AKIM	16.5 A
KUTU ADEDİ	20 Adet

LAY 5 Plastik Buton Serisi

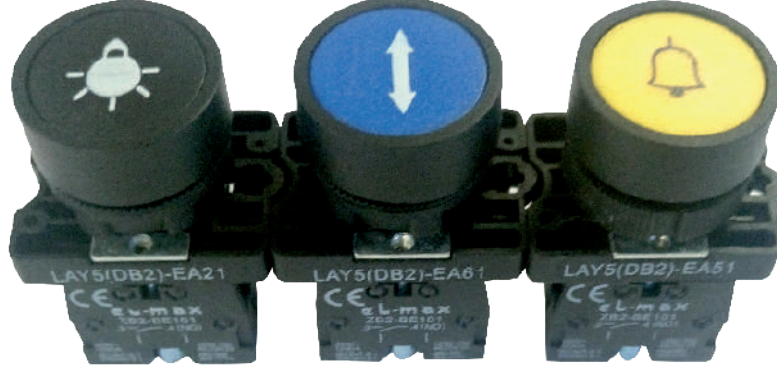

Yaylı Butonlar 250 VAC/3A (IP44)



Teknik Özellikler

ÜRÜN KODU	RENK	KONTAK	K. ADEDİ	AÇIKLAMA	FİYAT
LAY5 (DB2) EA31	Yeşil	1 NO	20	Q22mm Start Buton	1,20 \$
LAY5 (DB2) EA42	Kırmızı	1 NC	20	Q22mm Stop Buton	1,20 \$
LAY5 (DB2) EA51	Sarı	1 NO	20	Q22mm Start Buton	1,20 \$
LAY5 (DB2) EA21	Siyah	1 NO	20	Q22mm Start Buton	1,20 \$

İşaretili Yaylı Butonlar 250 VAC/3A (IP44)



Teknik Özellikler

ÜRÜN KODU	KONTAK	K. ADEDİ	AÇIKLAMA	FİYAT
LAY5 (DB2) EA21	1 NO	20	Q22mm Siyah Tabanlı, Beyaz Lamba	1,25 \$
LAY5 (DB2) EA51	1 NO	20	Q22mm Sarı Tabanlı, Siyah Zilli	1,25 \$
LAY5 (DB2) EA61	1 NO	20	Q22mm Mavi Tabanlı, Çift Yönlü Ok	1,25 \$
LAY5 (DB2) EA3341	1 NO	20	Q22mm Beyaz Tabanlı, Siyah Ok	1,25 \$
LAY5 (DB2) EA3351	1 NO	20	Q22mm Siyah Tabanlı, Beyaz Ok	1,25 \$

Mandal Butonlar 250 VAC/3A (IP44)



Teknik Özellikler

ÜRÜN KODU	KONUM	KONTAK	K. ADEDİ	AÇIKLAMA	FİYAT
LAY5 (DB2) ED21	0-1 Kalıcı	1 NO	20	Q22mm Kalıcı Mandal Buton	1,31 \$
LAY5 (DB2) ED33	1-0-2 Kalıcı	1 NO+1NO	20	Q22mm Kalıcı Mandal Buton	2,38 \$
LAY5 (DB2) ED53	1-0-2 Kayıcı	1 NO+1NO	20	Q22mm Kayıcı Mandal Buton	2,48 \$

LAY 5 Plastik Buton Serisi



40mm İkiz Butonlar 250 VAC/3A (IP44)

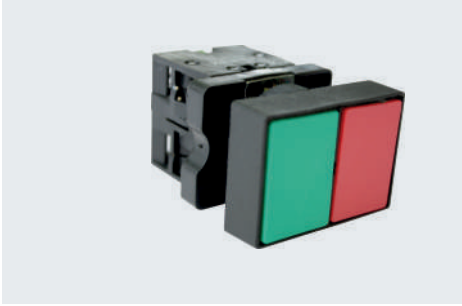

Teknik Özellikler

ÜRÜN KODU	RENK	KONTAK	K. ADEDİ	AÇIKLAMA	FİYAT
LAY5 (DB2) EL8325	Yeşil - Kırmızı	1 NO+1 NC	20	Q22mm İkiz Buton	3,30 \$

40mm Mantar Butonlar 250 VAC/3A (IP44)



Teknik Özellikler

ÜRÜN KODU	RENK	KONTAK	K. ADEDİ	AÇIKLAMA	FİYAT
LAY5 (DB2) ES542	■ Kırmızı	1 NC	20	Q40mm Acil Stop Mantar	1,80 \$
LAY5 (DB2) ES442	■ Kırmızı	1 NC	20	Q30mm Acil Stop Mantar	1,80 \$
LAY5 (DB2) ES142	■ Kırmızı	1 NC	20	Q40mm Anahtarlı Buton	3,94 \$
LAY5 (DB2) EC42	■ Kırmızı	1 NC	20	Q40mm Acil Stop Mantar	1,80 \$
LAY5 (DB2) EC31	■ Yeşil	1 NO	20	Q40mm Acil Stop Mantar	1,80 \$

Anahtarlı Buton



Teknik Özellikler

ÜRÜN KODU	KONUM	KONTAK	K. ADEDİ	AÇIKLAMA	FİYAT
LAY5 (DB2) EG41	Kalıcı	1 NO	20	Q22mm 0-1 Kalıcı	3,90 \$
LAY5 (DB2) EG61	Kayıcı	1 NO	20	Q22mm 0-1 Kayıcı	3,90 \$
LAY5 (DB2) EG73	1-0-2 Kayıcı	2 NO	20	Q22mm 1-0-2 Kayıcı	4,20 \$

LAY 5 Metal Buton Serisi



Yaylı Butonlar 250 VAC/3A (IP44)

Teknik Özellikler

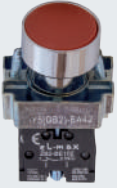

ÜRÜN KODU	RENK	KONTAK	K. ADEDİ	AÇIKLAMA	FİYAT
LAY5 (DB2) BA31	Yeşil	1 NO	20	Q22mm Start Buton	1,875 \$
LAY5 (DB2) BA42	Kırmızı	1 NC	20	Q22mm Stop Buton	1,875 \$
LAY5 (DB2) BA51	Sarı	1 NO	20	Q22mm Start Buton	1,875 \$
LAY5 (DB2) BA21	Siyah	1 NO	20	Q22mm Start Buton	1,875 \$

İşaretili Yaylı Butonlar 250 VAC/3A (IP44)

Teknik Özellikler



ÜRÜN KODU	RENK	KONTAK	K. ADEDİ	AÇIKLAMA	FİYAT
LAY5 (DB2) BA3341	Beyaz	1 NO	20	Q22mm Start Buton	2,10 \$
LAY5 (DB2) BA3351	Siyah	1 NO	20	Q22mm Start Buton	2,10 \$

40mm Mantar Butonlar 250 VAC/3A (IP44)

Teknik Özellikler



ÜRÜN KODU	RENK	KONTAK	K. ADEDİ	AÇIKLAMA	FİYAT
LAY5 (DB2) BS542	Kırmızı	1 NC	20	Q40mm Acil Stop Mantar Kalıcı	2,62 \$

40mm İkiz Butonlar 250 VAC/3A (IP44)

Teknik Özellikler



ÜRÜN KODU	RENK	KONTAK	K. ADEDİ	AÇIKLAMA	FİYAT
LAY5 (DB2) BL8325	Kır-Yeşil	1 NO+1NC	20	Q22mm İkiz Buton	3,94 \$

LAY 5 Metal Buton Serisi / Joystick Kontrol Yedek Kontak / Potansiyometre

Kalıcı Mandal Butonlar 250 VAC/3A (IP44)

Teknik Özellikler

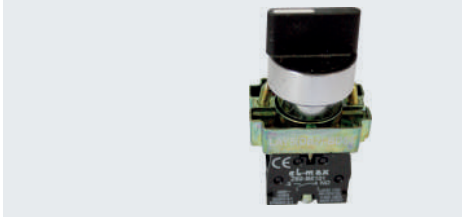

ÜRÜN KODU	KONUM	KONTAK	K. ADEDİ	AÇIKLAMA	FİYAT
LAY5 (DB2) BD21	0-1 Kalıcı	1 NO	20	Q22mm Kalıcı Mandal Buton	2,16 \$
LAY5 (DB2) BD33	1-0-2 Kalıcı	1NO + 1NO	20	Q22mm Kalıcı Mandal Buton	2,76 \$

Anahtarlı Buton

Teknik Özellikler

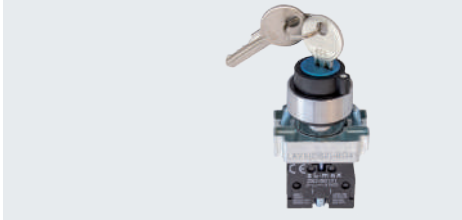

ÜRÜN KODU	KONUM	KONTAK	K. ADEDİ	AÇIKLAMA	FİYAT
LAY5 (DB2) BG41	0-1 Kalıcı	1 NO	20	Q22mm Anahtarlı Buton	4,13 \$

Joystick Kontrol

Teknik Özellikler



ÜRÜN KODU	RENK	KONTAK	K. ADEDİ	AÇIKLAMA	FİYAT
LAY5 (DB2) PA22	Gri-Siyah	2 N/O	10	Metal 2 Yönlü Yaylı	16,50 \$

Yedek Kontak Blok 250 VAC/3A (IP44)

Teknik Özellikler



ÜRÜN KODU	RENK	KONTAK	K. ADEDİ	AÇIKLAMA	FİYAT
LAY5 (DB2) BE101	Yeşil	1 NO	100	Yedek Kontak Blok	0,61 \$
LAY5 (DB2) BE102	Kırmızı	1 NC	100	Yedek Kontak Blok	0,61 \$

Ø 22mm Potansiyometre Tek Tur

Teknik Özellikler



ÜRÜN KODU	KONTAK	K. ADEDİ	AÇIKLAMA	FİYAT
ELX PT 5K	5K (Tek Tur)	10	Ø22mm Potansiyometre	7,56 \$
ELX PT 10K	10K (Tek Tur)	10	Ø22mm Potansiyometre	7,56 \$

ELX2M Plastik Buton Serisi

Yaylı Butonlar Q22mm



Teknik Özellikler

ÜRÜN KODU	RENK	KONTAK	K. ADEDİ	AÇIKLAMA	FİYAT
ELX2M-10	■ Yeşil	1 NO	10	Yaylı Buton	2,40 \$
ELX2M-01	■ Kırmızı	1 NC	10	Yaylı Buton	2,40 \$
ELX2M-11	■ Sarı	1 NO	10	Yaylı Buton	2,40 \$
ELX2M-21	■ Mavi	1 NO	10	Yaylı Buton	2,40 \$
ELX2M-31	□ Beyaz	1 NO	10	Yaylı Buton	2,40 \$
ELX2M-41	■ Siyah	1 NO	10	Yaylı Buton	2,40 \$

İşaretli Yaylı Butonlar Q22mm



Teknik Özellikler

ÜRÜN KODU	KONTAK	K. ADEDİ	AÇIKLAMA	FİYAT
ELX2M-1011	1 NO	10	İşaretli Yaylı Buton 	2,80 \$
ELX2M-1012	1 NC	10	İşaretli Yaylı Buton 	2,80 \$
ELX2M-1013	1 NO	10	İşaretli Yaylı Buton 	2,80 \$
ELX2M-1014	1 NO	10	İşaretli Yaylı Buton 	2,80 \$

İşikli Yaylı Butonlar Q22mm



Teknik Özellikler

ÜRÜN KODU	RENK	KONTAK	K. ADEDİ	AÇIKLAMA	FİYAT
ELX2M-10L	■ Yeşil	1 NO	10	İşikli Yaylı Buton 220V AC/DC	4,18 \$
ELX2M-01L	■ Kırmızı	1 NC	10	İşikli Yaylı Buton 220V AC/DC	4,18 \$
ELX2M-11L	■ Sarı	1 NO	10	İşikli Yaylı Buton 220V AC/DC	4,18 \$
ELX2M-21L	■ Mavi	1 NO	10	İşikli Yaylı Buton 220V AC/DC	4,18 \$
ELX2M-31L	□ Beyaz	1 NO	10	İşikli Yaylı Buton 220V AC/DC	4,18 \$
ELX2M-10L-110	■ Yeşil	1 NO	10	İşikli Yaylı Buton 110V AC/DC	4,18 \$
ELX2M-01L-110	■ Kırmızı	1NC	10	İşikli Yaylı Buton 110V AC/DC	4,18 \$
ELX2M-11L-110	■ Sarı	1 NO	10	İşikli Yaylı Buton 110V AC/DC	4,18 \$
ELX2M-21L-110	■ Mavi	1 NO	10	İşikli Yaylı Buton 110V AC/DC	4,18 \$
ELX2M-31L-110	□ Beyaz	1 NO	10	İşikli Yaylı Buton 110V AC/DC	4,18 \$
ELX2M-10L-24	■ Yeşil	1 NO	10	İşikli Yaylı Buton 24V AC/DC	4,18 \$
ELX2M-01L-24	■ Kırmızı	1NC	10	İşikli Yaylı Buton 24V AC/DC	4,18 \$
ELX2M-11L-24	■ Sarı	1 NO	10	İşikli Yaylı Buton 24V AC/DC	4,18 \$
ELX2M-21L-24	■ Mavi	1 NO	10	İşikli Yaylı Buton 24V AC/DC	4,18 \$
ELX2M-31L-24	□ Beyaz	1 NO	10	İşikli Yaylı Buton 24V AC/DC	4,18 \$

ELX2M Plastik Buton Serisi

Kalıcı Mandal Butonlar Q22mm



Teknik Özellikler

ÜRÜN KODU	KONTAK	K. ADEDİ	AÇIKLAMA	FİYAT
ELX2M-10KL	1 NO	10	0 - 1 Mandal Buton	2,80 \$
ELX2M-20KL	2 NO	10	1 - 0 - 2 Mandal Buton	3,80 \$

Kayıcı Mandal Butonlar Q22mm



Teknik Özellikler

ÜRÜN KODU	KONTAK	K. ADEDİ	AÇIKLAMA	FİYAT
ELX2M-10KY	1 NO	10	0 - 1 Mandal Buton	3,10 \$
ELX2M-20KY	2 NO	10	1 - 0 - 2 Mandal Buton	4,15 \$

Anahtarlı Kalıcı Butonlar Q22mm



Teknik Özellikler

ÜRÜN KODU	KONTAK	K. ADEDİ	AÇIKLAMA	FİYAT
ELX2M-10AN	1 NO	10	0 - 1 Anahtarlı Buton	4,15 \$
ELX2M-20AN	2 NO	10	1 - 0 - 2 Anahtarlı Buton	5,14 \$

ELX2M Plastik Buton Serisi Buton Serisi Aksesuarları

Işıklı Kalıcı Mandal Butonlar Q22mm



Teknik Özellikler

ÜRÜN KODU	RENK	KONTAK	K. ADEDİ	AÇIKLAMA	FİYAT
ELX2M-10LK	Yeşil	1 NO	10	0-1 Işıklı MANDAL Buton 220V AC/DC	4,65 \$
ELX2M-01LK	Kırmızı	1 NC	10	0-1 Işıklı MANDAL Buton 220V AC/DC	4,65 \$
ELX2M-11LK	Sarı	1 NO	10	0-1 Işıklı MANDAL Buton 220V AC/DC	4,65 \$
ELX2M-10LK-110	Yeşil	1 NO	10	0-1 Işıklı MANDAL Buton 110V AC/DC	4,65 \$
ELX2M-01LK-110	Kırmızı	1 NC	10	0-1 Işıklı MANDAL Buton 110V AC/DC	4,65 \$
ELX2M-11LK-110	Sarı	1 NO	10	0-1 Işıklı MANDAL Buton 110V AC/DC	4,65 \$
ELX2M-10LK-24	Yeşil	1 NO	10	0-1 Işıklı MANDAL Buton 24V AC/DC	4,65 \$
ELX2M-01LK-24	Kırmızı	1 NC	10	0-1 Işıklı MANDAL Buton 24V AC/DC	4,65 \$
ELX2M-11LK-24	Sarı	1 NO	10	0-1 Işıklı MANDAL Buton 24V AC/DC	4,65 \$
ELX2M-20LK	Yeşil	2 NO	10	1-0-2 Işıklı MANDAL Buton 220V AC/DC	5,40 \$
ELX2M-02LK	Kırmızı	2 NC	10	1-0-2 Işıklı MANDAL Buton 220V AC/DC	5,40 \$
ELX2M-21LK	Sarı	2 NO	10	1-0-2 Işıklı MANDAL Buton 220V AC/DC	5,40 \$
ELX2M-20LK-110	Yeşil	2 NO	10	1-0-2 Işıklı MANDAL Buton 110V AC/DC	5,40 \$
ELX2M-02LK-110	Kırmızı	2 NC	10	1-0-2 Işıklı MANDAL Buton 110V AC/DC	5,40 \$
ELX2M-21LK-110	Sarı	2 NO	10	1-0-2 Işıklı MANDAL Buton 110V AC/DC	5,40 \$
ELX2M-20LK-24	Yeşil	2 NO	10	1-0-2 Işıklı MANDAL Buton 24V AC/DC	5,40 \$
ELX2M-02LK-24	Kırmızı	2 NC	10	1-0-2 Işıklı MANDAL Buton 24V AC/DC	5,40 \$
ELX2M-21LK-24	Sarı	2 NO	10	1-0-2 Işıklı MANDAL Buton 24V AC/DC	5,40 \$

Kalıcı Mantar Butonlar Q22mm



Teknik Özellikler

ÜRÜN KODU	KONTAK	K. ADEDİ	AÇIKLAMA	FİYAT
ELX2M-01AS	1 NC	10	Stop Mantar Buton	3,30 \$

İkiz Butonlar Q22mm

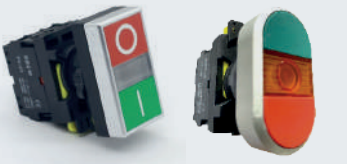

Teknik Özellikler

ÜRÜN KODU	KONTAK	K. ADEDİ	AÇIKLAMA	FİYAT
ELX2M-11TBR	1 NO + 1 NC	10	Start	4,30 \$
ELX2M-11TBL	1 NO + 1 NC	10	Işıklı İkiz Buton 220V AC/DC	5,70 \$

Buton Aksesuarları Q22mm



Teknik Özellikler

ÜRÜN KODU	KONTAK	K. ADEDİ	AÇIKLAMA	FİYAT
ELX2M-11A	1 NO	250	Start Kontak	1,04 \$
ELX2M-01A	1 NC	250	Stop Kontak	1,04 \$

LAY5 Plastik Buton Serisi



Plastik Yaylı Butonlar

Teknik Özellikler



ÜRÜN KODU	RENK	KONTAK	K. ADEDİ	AÇIKLAMA	FİYAT
LAY5-AA11	<input type="checkbox"/> Beyaz	1 NO	10	Q22mm Start Buton	2,40 \$
LAY 5-AA21	<input checked="" type="checkbox"/> Siyah	1 NO	10	Q22mm Start Buton	2,40 \$
LAY5-AA31	<input checked="" type="checkbox"/> Yeşil	1 NO	10	Q22mm Start Buton	2,40 \$
LAY5-AA51 Zilli	<input checked="" type="checkbox"/> Sarı	1 NO	10	Q22mm Start Buton	2,70 \$
LAY5-AA61 Oklu	<input checked="" type="checkbox"/> Mavi	1 NO	10	Q22mm Start Buton	2,70 \$
LAY5-AA42	<input checked="" type="checkbox"/> Kırmızı	1 NC	10	Q22mm Stop Buton	2,40 \$

Plastik İşaretli Yaylı Butonlar

Teknik Özellikler



ÜRÜN KODU	RENK	KONTAK	K. ADEDİ	AÇIKLAMA	FİYAT
LAY5-AA3341	<input type="checkbox"/> Beyaz	1 NO	10	Q22mm Start Buton	2,70 \$
LAY5-AA3351	<input checked="" type="checkbox"/> Siyah	1 NO	10	Q22mm Start Buton	2,70 \$

Plastik İkiz Butonlar

Teknik Özellikler



ÜRÜN KODU	RENK	KONTAK	K. ADEDİ	AÇIKLAMA	FİYAT
LAY5-AL8325	Kırmızı-Yeşil	1NO / 1NC	10	Ø 22 mm İkiz Butonlar	6,30 \$

Plastik Kalıcı Mandal Butonlar

Teknik Özellikler



ÜRÜN KODU	KONUM	KONTAK	K. ADEDİ	AÇIKLAMA	FİYAT
LAY5-AD21	0 1 Kalıcı	1NO	10	Ø 22 mm Mandal Butonlar 3 Kontak Takılabilir	3,20 \$
LAY5-AD33	1 0 2 Kalıcı	1NO / 1NO	10	Ø 22 mm Mandal Butonlar	4,30 \$

LAY5 Plastik Buton Serisi

Plastik Ø 40 mm Mantar Acil Stop

Teknik Özellikler



ÜRÜN KODU	RENK	KONTAK	K. ADEDİ	AÇIKLAMA	FİYAT
LAY5-AS542	■ Kırmızı	1NC	10	Ø 22 mm Mantar Butonlar	4,30 \$

Plastik Anahtarlı Butonlar

Teknik Özellikler



ÜRÜN KODU	RENK	KONTAK	K. ADEDİ	AÇIKLAMA	FİYAT
LAY5-AG21	0 1 Kalıcı	1NO	10	Ø 22 mm Mantar Butonlar	6,20 \$
LAY5-AG33	1 0 2 Kalıcı	1NO + 1NO	10	Ø 22 mm Mantar Butonlar	7,20 \$

Plastik Led'li Işıklı Yaylı Butonlar

Teknik Özellikler



ÜRÜN KODU	RENK	KONTAK	K. ADEDİ	AÇIKLAMA	FİYAT
LAY5-AW3175	Beyaz	1NO	10	Ø 22 mm Led 110-240 V AC	5,96 \$
LAY5-AW3375	Yeşil	1NO	10	Ø 22 mm Led 110-240 V AC	5,96 \$
LAY5-AW3575	Sarı	1NO	10	Ø 22 mm Led 110-240 V AC	5,96 \$
LAY5-AW3675	Mavi	1NO	10	Ø 22 mm Led 110-240 V AC	5,96 \$
LAY5-AW3475	Kırmızı	1 NC	10	Ø 22 mm Led 110-240 V AC	5,96 \$
LAY5-AW3175-24	Beyaz	1 NO	10	Ø 22 mm Led 10 - 30V AC-DC	5,96 \$
LAY5-AW3375-24	Yeşil	1 NO	10	Ø 22 mm Led 10 - 30V AC-DC	5,96 \$
LAY 5-AW3575-24	Sarı	1 NO	10	Ø 22 mm Led 10 - 30V AC-DC	5,96 \$
LAY5-AW3675-24	Mavi	1 NO	10	Ø 22 mm Led 10 - 30V AC-DC	5,96 \$
LAY5-AW3475-24	Kırmızı	1 NC	10	Ø 22 mm Led 10 - 30V AC-DC	5,96 \$

Plastik Led'li Işıklı 0-1 Mandal

Teknik Özellikler



ÜRÜN KODU	RENK	KONTAK	K. ADEDİ	AÇIKLAMA	FİYAT
LAY5-AK-124L	Kırmızı	1NC+1NC	10	Ø 22 mm 0-1 Kalıcı Led 220VAC	8,00 \$
LAY5-AK-123L	Yeşil	1NO+	10	Ø 22 mm 0-1 Kalıcı Led 220VAC	8,00 \$
LAY5-AK-125L	Sarı	1NO+	10	Ø 22 mm 0-1 Kalıcı Led 220VAC	8,00 \$
LAY5-AK-124L 24	Kırmızı	1NC+1NC	10	Ø 22 mm 0-1 Kalıcı Led 24VAC/DC	8,00 \$
LAY5-AK-123L 24	Yeşil	1NC+1NC	10	Ø 22 mm 0-1 Kalıcı Led 24VAC/DC	8,00 \$
LAY5-AK-125L 24	Sarı	1NO	10	Ø 22 mm 0-1 Kalıcı Led 24VAC/DC	8,00 \$

Plastik Led'li Işıklı 0-1-2 Mandal

Teknik Özellikler



ÜRÜN KODU	RENK	KONTAK	K. ADEDİ	AÇIKLAMA	FİYAT
LAY5-AK-324L	Kırmızı	1NC/1NC	10	Ø 22 mm 1-0-2 Kalıcı Led 220VAC	8,00 \$
LAY5-AK-323L	Yeşil	1NC/1NC	10	Ø 22 mm 1-0-2 Kalıcı Led 220VAC	8,00 \$
LAY5-AK-325L	Sarı	1NC/1NC	10	Ø 22 mm 1-0-2 Kalıcı Led 220VAC	8,00 \$
LAY5-AK-324L 24	Kırmızı	1NC/1NC	10	Ø 22 mm 1-0-2 Kalıcı Led 24VAC/DC	8,00 \$
LAY5-AK-323L 24	Yeşil	1NC/1NC	10	Ø 22 mm 1-0-2 Kalıcı Led 24VAC/DC	8,00 \$
LAY5-AK-325L 24	Sarı	1NC/1NC	10	Ø 22 mm 1-0-2 Kalıcı Led 24VAC/DC	8,00 \$

Yedek Kontak Blok

Yedek Kontak Blok 250 VAC/3A (IP44)

Teknik Özellikler



ÜRÜN KODU	RENK	KONTAK	K. ADEDİ	AÇIKLAMA	FİYAT
LAYS BE101	Yeşil	1 NO	100	Yedek Kontak Blok	1,10 \$
LAYS BE102	Kırmızı	1 NC	100	Yedek Kontak Blok	1,10 \$

Sirenler

Elektronik Sirenler Ø 50mm (120 dB)

Teknik Özellikler



ÜRÜN KODU	RENK	VOLTAJ	K. ADEDİ	AÇIKLAMA	FİYAT
ES -50 -12-24	■ Siyah	12-24V.AC/DC	6	Elektronik Siren Plastik Gövde	5,00 \$

Buzzer ve Ledli Sinyal Lambaları

Led'li Buzzer Q22mm (90dB)

Teknik Özellikler



ÜRÜN KODU	RENK	VOLTAJ	K. ADEDİ	AÇIKLAMA	FİYAT
AD 16 - 22SM/R	Kırmızı	220V AC	10	Q22mm Led'li Buzzer	2,50 \$
AD 16 - 22SM/R	Kırmızı	24V AC/DC	10	Q22mm Led'li Buzzer	2,50 \$

Led'li Sinyal Q22MM 220/240V AC

Teknik Özellikler



ÜRÜN KODU	RENK	VOLTAJ	K. ADEDİ	AÇIKLAMA	FİYAT
AD 22 - 22DS/R	Kırmızı	230V AC	10	Q22mm Led'li Sinyal	0,80 \$
AD 22 - 22DS/G	Yeşil	230V AC	10	Q22mm Led'li Sinyal	0,80 \$
AD 22 - 22DS/Y	Sarı	230V AC	10	Q22mm Led'li Sinyal	0,80 \$
AD 22 - 22DS/B	Mavi	230V AC	10	Q22mm Led'li Sinyal	1,19 \$
AD 22 - 22DS/W	Beyaz	230V AC	10	Q22mm Led'li Sinyal	1,19 \$

Led'li Sinyal Q22MM 24VAC/DC

Teknik Özellikler



ÜRÜN KODU	RENK	VOLTAJ	K. ADEDİ	AÇIKLAMA	FİYAT
AD 22 - 22DS/R	Kırmızı	24V AC-DC	10	Q22mm Led'li Sinyal	0,80 \$
AD 22 - 22DS/G	Yeşil	24V AC-DC	10	Q22mm Led'li Sinyal	0,80 \$
AD 22 - 22DS/Y	Sarı	24V AC-DC	10	Q22mm Led'li Sinyal	0,80 \$
AD 22 - 22DS/B	Mavi	24V AC-DC	10	Q22mm Led'li Sinyal	1,19 \$
AD 22 - 22DS/W	Beyaz	24V AC-DC	10	Q22mm Led'li Sinyal	1,19 \$

Ledli Voltmetre - Ampermetre Sinyal Lambaları

Q22 mm Ledli Voltmetre Göstergeli Sinyal Lambaları



Teknik Özellikler

ÜRÜN KODU	RENK	VOLTAJ	ÇAP (mm)	K. ADEDİ	FİYAT
AD22-22DS/RV	■ KIRMIZI	12-500 VAC	22 mm	10	3,88 \$
AD22-22DS/GV	■ YEŞİL	12-500 VAC	22 mm	10	3,88 \$
AD22-22DS/YV	■ SARI	12-500 VAC	22 mm	10	3,88 \$

Q22 mm Ledli Voltmetre - Ampermetre Göstergeli Sinyal Lambaları



Teknik Özellikler

ÜRÜN KODU	RENK	VOLTAJ	ÇAP (mm)	K. ADEDİ	FİYAT
AD22-22DS/RAV	■ KIRMIZI	12-500 VAC 0-100 A	22 mm	10	9,50 \$
AD22-22DS/GAV	■ YEŞİL	12-500 VAC 0-100 A	22 mm	10	9,50 \$
AD22-22DS/YAV	■ SARI	12-500 VAC 0-100 A	22 mm	10	9,50 \$

Q22 mm Ledli Ampermetre Göstergeli Sinyal Lambaları



Teknik Özellikler

ÜRÜN KODU	RENK	AMP	ÇAP (mm)	K. ADEDİ	FİYAT
AD22-22DS/RA	■ KIRMIZI	0-100 A Akım Trafolu	22 mm	10	7,82 \$
AD22-22DS/GA	■ YEŞİL	0-100 A Akım Trafolu	22 mm	10	7,82 \$
AD22-22DS/YA	■ SARI	0-100 A Akım Trafolu	22 mm	10	7,82 \$

XCK Plastik Gövdeli Limit Switch



XCK-SUM 211



XCK-SUM 331



XCK-SUM 332RS



XCK-SİM 311



XCK-SİM 411



XCK-SEM 121



XCK-SEM 122



XCK-SEL 123R



XCK-SOM 102

Tüm Özellikleriyle
ÇOK ÖZEL

XCK Plastik Gövdeli Limit Switch Özellikleri

- Estetik plastik gövde • Paslanmaz makara ve kol • Yüksek mekanik dayanıklılık • Ekstra geniş $\pm 95^\circ$ hareketli, • PG 13.5 kablo rekoru kullanılabilir • Kompakt gövde • 1NO/1NC 2 anahtarlama kontak • Hareketli çift kontaklar • PG 13.5/M20x1.5 kablo rakoru girişli • IP67
- Kapak içi lastik conta • Tüm modellerde tahrik kafa contası • Gövde vidası M3+Somon sıkmalı • Kontak bloğunu çıkartarak dışarda rahat bağlantı olanağı • Gövde kapak vidası kapak üzerinden düşmez • Uluslararası gövde standartlarında.

XCK-SUM 211

XCK Plastik Gövdeli
Limit Switch

FİYAT: 5,98 \$



ÜRÜN KODU	XCK-SUM 211 (CLS101)
KONTAK TİPİ	1NO+1NC
AÇIKLAMA	Doğrusal Hareketli Metal Pim
KUTU ADEDİ	10 Adet

XCK-SUM 331

XCK Plastik Gövdeli
Limit Switch

FİYAT: 5,42 \$



ÜRÜN KODU	XCK-SUM 331 (CLS103)
KONTAK TİPİ	1NO+1NC
AÇIKLAMA	Doğrusal Hareketli 11mm Metal Makaralı Pim
KUTU ADEDİ	10 Adet

XCK-SUM 332RS

XCK Plastik Gövdeli
Limit Switch

FİYAT: 5,42 \$



ÜRÜN KODU	XCK-SUM 332RS (CLS103R)
KONTAK TİPİ	1NO+1NC
AÇIKLAMA	Doğrusal Hareketli Resetli 11mm Metal Makaralı Pim
KUTU ADEDİ	10 Adet

Üst kapak vidası M3 kapaktan düşmez. Kontak bloğu çıkarılabilir. Rahatlıkla kablo bağlanır.



XCK Plastik Gövdeli Limit Switch

XCK-SİM 311

XCK Plastik Gövdeli
Limit Switch

FİYAT: 5,98 \$



ÜRÜN KODU	XCK-SİM 311 (CLS111)
KONTAK TİPİ	1NO+1NC
AÇIKLAMA	Açısal Hareketli 14 mm Metal Makaralı Kol
KUTU ADEDİ	10 Adet

XCK-SİM 411

XCK Plastik Gövdeli
Limit Switch

FİYAT: 5,98 \$



ÜRÜN KODU	XCK-SİM 411 (CLS127)
KONTAK TİPİ	1NO+1NC
AÇIKLAMA	Açısal Hareketli Ters Açılı 14 mm Metal Makaralı Kol
KUTU ADEDİ	10 Adet

XCK-SEP 121

XCK Plastik Gövdeli
Limit Switch

FİYAT: 5,98 \$



ÜRÜN KODU	XCK-SEP 121
KONTAK TİPİ	1NO+1NC
AÇIKLAMA	Açısal Hareketli 18 mm Plastik Makaralı Döner Kol
KUTU ADEDİ	10 Adet

XCK-SEM 121

XCK Plastik Gövdeli
Limit Switch

FİYAT: 5,98 \$



ÜRÜN KODU	XCK-SEM 121 (CLS121)
KONTAK TİPİ	1NO+1NC
AÇIKLAMA	Açısal Hareketli 18 mm Metal Makaralı Döner Kol
KUTU ADEDİ	10 Adet

XCK-SEM 122

XCK Plastik Gövdeli
Limit Switch

FİYAT: 6,06 \$



ÜRÜN KODU	XCK-SEM 122 (CLS131)
KONTAK TİPİ	1NO+1NC
AÇIKLAMA	Açısal Hareketli Ayarlanabilir 18 mm Metal Makaralı Döner Kol
KUTU ADEDİ	10 Adet

XCK-SEM 123

XCK Plastik Gövdeli
Limit Switch

FİYAT: 6,06 \$



ÜRÜN KODU	XCK-SEM 123 (CLS131M)
KONTAK TİPİ	1NO+1NC
AÇIKLAMA	Açısal Hareketli Ayarlanabilir 18 mm Metal Makaralı Döner Uzun Kol
KUTU ADEDİ	10 Adet

Üst kapak vidası M3 kapaktan düşmez. Kontak bloğu çıkarılabilir. Rahatlıkla kablo bağlanır.

XCK Plastik Gövdeli Limit Switch

XCK-SEL 123

XCK Plastik Gövdeli
Limit Switch

FİYAT: 5,14 \$



ÜRÜN KODU	XCK-SEL 123 (CLS191)
KONTAK TİPİ	1NO+1NC
AÇIKLAMA	Açısal Hareketli Ayarlanabilir 50 mm Lastik Makaralı Döner Kol
KUTU ADEDİ	10 Adet

XCK-SEL 123R

XCK Plastik Gövdeli
Limit Switch

FİYAT: 7,22 \$



ÜRÜN KODU	XCK-SEL 123 R (CLS191R)
KONTAK TİPİ	1NO+1NC
AÇIKLAMA	Açısal Hareketli Ayarlanabilir 50 mm Lastik Makaralı Resetli Döner Kol
KUTU ADEDİ	10 Adet

XCK-SOM 101

XCK Plastik Gövdeli
Limit Switch

FİYAT: 6,29\$



ÜRÜN KODU	XCK-SOM 101 (CLS161)
KONTAK TİPİ	1NO+1NC
AÇIKLAMA	Açısal Hareketli Spiral Telli Çok Yönlü Kol
KUTU ADEDİ	10 Adet

XCK-SOM 102

XCK Plastik Gövdeli
Limit Switch

FİYAT: 6,29 \$



ÜRÜN KODU	XCK-SOM 102
KONTAK TİPİ	1NO+1NC
AÇIKLAMA	Açısal Hareketli Metal Uçlu Metal Spiral Çok Yönlü Kol
KUTU ADEDİ	10 Adet



Yanmaz, kırılmaz özel plastik gövde kollu ürünlerde 5° - 90° hassas ayar olanağı, uzun kol mesafesi



CSA Metal Gövdeli Limit Switch

CSA 001

CSA METAL GÖVDELİ
LİMİT SWITCH

FİYAT: 15,30 \$



ÜRÜN KODU	CSA-001
KONTAK TİPİ	1NO+1NC
AÇIKLAMA	Dikey Buton Tahrikli
KUTU ADEDİ	10 Adet

CSA 003

CSA METAL GÖVDELİ
LİMİT SWITCH

FİYAT: 15,30 \$



ÜRÜN KODU	CSA-003
KONTAK TİPİ	1NO+1NC
AÇIKLAMA	Dikey Metal Makara Tahrikli
KUTU ADEDİ	10 Adet

CSA 004

CSA METAL GÖVDELİ
LİMİT SWITCH

FİYAT: 15,30 \$



ÜRÜN KODU	CSA-004
KONTAK TİPİ	1NO+1NC
AÇIKLAMA	Dikey Ters Metal Makara Tahrikli
KUTU ADEDİ	10 Adet

CSA 012

CSA METAL
GÖVDELİ LİMİT
SWITCH

FİYAT: 15,30 \$



ÜRÜN KODU	CSA-012
KONTAK TİPİ	1NO+1NC
AÇIKLAMA	Yatay Metal Makara Kol Tahrikli
KUTU ADEDİ	10 Adet

CSA 031

CSA METAL
GÖVDELİ LİMİT
SWITCH

FİYAT: 15,30 \$



ÜRÜN KODU	CSA-031
KONTAK TİPİ	1NO+1NC
AÇIKLAMA	Ø 18mm Ayarlanabilir Sağ-Sol Metal Makara Tahrikli
KUTU ADEDİ	10 Adet

CSA 061

CSA METAL
GÖVDELİ LİMİT
SWITCH

FİYAT: 15,30 \$



ÜRÜN KODU	CSA-061
KONTAK TİPİ	1NO+1NC
AÇIKLAMA	Spiral Metal Tel Tahrikli
KUTU ADEDİ	10 Adet

CSA 071

CSA METAL
GÖVDELİ LİMİT
SWITCH

FİYAT: 15,30 \$



ÜRÜN KODU	CSA-071
KONTAK TİPİ	1NO+1NC
AÇIKLAMA	Spiral Plastik Yay Tahrikli
KUTU ADEDİ	10 Adet

Üst kapak vidası M3 kapaktan düşmez. Kontak bloğu çıkarılabilir. Rahatlıkla kablo bağlanır.

Mini Switch (Silver Contact)

XZ-15GQ-B

Mini Switch
(Silver Contact) / 15 Amper

FİYAT: 3,35 \$



ÜRÜN KODU	XZ-15GQ-B (CM1307)
KONTAK TİPİ	1NO+1NC
AÇIKLAMA	Kalın Uzun Pimli
AMPER	15 A
KUTU ADEDİ	20 Adet

XZ-15GQ22-B

Mini Switch
(Silver Contact) / 15 Amper

FİYAT: 3,60 \$



ÜRÜN KODU	XZ-15GQ22-B
KONTAK TİPİ	(CM1308)
AÇIKLAMA	1NO+1NC Yatay Metal Makara Pim
AMPER	15 A
KUTU ADEDİ	20 Adet

XZ-15GQ21-B

Mini Switch
(Silver Contact) / 15 Amper

FİYAT: 3,60 \$



ÜRÜN KODU	XZ-15GQ21-B (CM1309)-
KONTAK TİPİ	1NO+1NC
AÇIKLAMA	Dikey Metal Makara Pim
AMPER	15 A
KUTU ADEDİ	20 Adet

XZ-15GW-B

Mini Switch
(Silver Contact) / 15 Amper

FİYAT: 3,33 \$



ÜRÜN KODU	XZ-15GW-B (CM1701)
KONTAK TİPİ	1NO+1NC
AÇIKLAMA	Uzun Palet
AMPER	15 A
KUTU ADEDİ	20 Adet

XZ-15GW22-B

Mini Switch
(Silver Contact) / 15 Amper

FİYAT: 3,05 \$



ÜRÜN KODU	XZ-15GW22-B (CM1704)
KONTAK TİPİ	1NO+1NC
AÇIKLAMA	Kısa Palet Metal Makaralı
AMPER	15 A
KUTU ADEDİ	20 Adet

XZ-15GW3-B

Mini Switch
(Silver Contact) / 15 Amper

FİYAT: 4,73 \$



ÜRÜN KODU	XZ-15GW3-B
KONTAK TİPİ	1NO+1NC
AÇIKLAMA	Orta Palet Metal Makaralı
AMPER	15 A
KUTU ADEDİ	20 Adet

Mini Switch (Silver Contact)

XZ-15GW2-B
Mini Switch
(Silver Contact) / 15 Amper

FİYAT: 3,33 \$



ÜRÜN KODU	XZ-15GW2-B (CM1703)
KONTAK TİPİ	1NO+1NC
AÇIKLAMA	Uzun Palet Metal Makaralı
AMPER	15 A
KUTU ADEDİ	20 Adet

XAP-Y
Mini Switch Kapağı

FİYAT: 1,24 \$



ÜRÜN KODU	XAP-Y
AÇIKLAMA	Mini Siviç Koruma Kılıfı 45° Açılı Kauçuk
AMPER	15 A
KUTU ADEDİ	100 Adet



Mikro Switch (Silver Contact)

XV-15-1C25

Mikro Switch
(Silver Contact) / 15 Amper

FİYAT: 1,47 \$



ÜRÜN KODU	XV-15-1C25
KONTAK TİPİ	1NO+1NC
AÇIKLAMA	Buton Tip Pimli
KUTU ADEDİ	100 Adet

XV-151-1C25

Mikro Switch
(Silver Contact) / 15 Amper

FİYAT: 1,47 \$



ÜRÜN KODU	XV-151-1C25
KONTAK TİPİ	1NO+1NC
AÇIKLAMA	Kısa Palet
KUTU ADEDİ	100 Adet

XV-152-1C25

Mikro Switch
(Silver Contact) / 15 Amper

FİYAT: 1,47 \$



ÜRÜN KODU	XV-152-1C25 Orta Palet
KONTAK TİPİ	1NO+1NC
AÇIKLAMA	Orta Palet
KUTU ADEDİ	100 Adet

XV-153-1C25

Mikro Switch
(Silver Contact) /
15 Amper

FİYAT: 1,47 \$



ÜRÜN KODU	XV-153-1C25
KONTAK TİPİ	1NO+1NC
AÇIKLAMA	Uzun Palet
KUTU ADEDİ	100 Adet

XV-154-1C25

Mikro Switch
(Silver Contact) /
15 Amper

FİYAT: 1,47 \$



ÜRÜN KODU	XV-154-1C25
KONTAK TİPİ	1NO+1NC
AÇIKLAMA	Çengel Palet
KUTU ADEDİ	100 Adet

XV-155-1C25

Mikro Switch
(Silver Contact) /
15 Amper

FİYAT: 1,47 \$



ÜRÜN KODU	XV-155-1C25
KONTAK TİPİ	1NO+1NC
AÇIKLAMA	Kısa Palet Pls. Makaralı
KUTU ADEDİ	100 Adet

XV-156-1C25

Mikro Switch
(Silver Contact) /
15 Amper

FİYAT: 1,47 \$



ÜRÜN KODU	XV-156-1C25
KONTAK TİPİ	1NO+1NC
AÇIKLAMA	Uzun Palet Makaralı
KUTU ADEDİ	100 Adet

İzoleli Kablo Yüksükleri (Bakır Copper)

Standart : DIN 46228
 Malzeme : Bakır Kalay Kaplı
 İzolasyon : Naylon
 Çalışma Sıcaklığı : Max 105°
 600 Volt Arası



İzoleli Kablo Yüksükleri Wire End Sleeves Insul / KUTULU

ÜRÜN KODU	KESİT (mm)	FRANCE NORM	BOYUTLAR		PLS KUTU / ADET	FİYAT
			F mm	L mm		
ELX IY 3005	0,50	Beyaz	8	12	1,000	0,102 ₺
ELX IY 3007	0,75	Mavi	8	14	1,000	0,102 ₺
ELX IY 3010	1	Kırmızı	8	14	1,000	0,102 ₺
ELX IY 3015	1,5	Siyah	8	14	1,000	0,112 ₺
ELX IY 3025	2,5	Gri	8	14	500	0,153 ₺
ELX IY 3040	4	Turuncu	10	17	500	0,249 ₺
ELX IY 3060	6	Yeşil	12	20	250	0,313 ₺
ELX IY 3100	10	Kahverengi	12	22	100	0,416 ₺
ELX IY 3160	16	Bej	12	24	100	0,620 ₺
ELX IY 3250	25	Siyah	16	28	50	1,20 ₺
ELX IY 3350	35	Kırmızı	16	30	50	1,308 ₺
ELX IY 3500	50	Mavi	20	36	25	2,59 ₺

İzoleli Kablo Yüksükleri Wire End Sleeves Insul / KUTULU

ÜRÜN KODU	KESİT (mm)	GERMANY NORM	BOYUTLAR		PLS KUTU / ADET	FİYAT
			F mm	L mm		
ELX IY 2005	0,50	Turuncu	8	12	1,000	0,102 ₺
ELX IY 2007	0,75	Beyaz	8	14	1,000	0,102 ₺
ELX IY 2010	1	Sarı	8	14	1,000	0,102 ₺
ELX IY 2015	1,5	Kırmızı	8	14	1,000	0,112 ₺
ELX IY 2025	2,5	Mavi	8	14	500	0,153 ₺
ELX IY 2040	4	Gri	10	17	500	0,249 ₺
ELX IY 2060	6	Siyah	12	20	250	0,313 ₺
ELX IY 2100	10	Bej	12	22	100	0,416 ₺
ELX IY 2160	16	Yeşil	12	24	100	0,620 ₺
ELX IY 2250	25	Kahverengi	16	28	50	1,20 ₺
ELX IY 2350	35	Bej	16	30	50	1,308 ₺
ELX IY 2500	50	Siyah	20	36	25	2,590 ₺

İzoleli Çift Girişli Kablo Yüksükleri Twin Wire End Sleeves Insul / KUTULU

ÜRÜN KODU	KESİT mm	FRANCE NORM	GERMANY NORM	BOYUTLAR		PLS KUTU	FİYAT
		Fransız	Alman	F mm	L mm	Adet	
ELX CY 23005	0,50	Beyaz	Kahverengi	8	14	1,000	0,200 ₺
ELX CY 23007	0,75	Mavi	Beyaz	8	14	500	0,205 ₺
ELX CY 23010	1	Kırmızı	Sarı	8	14	500	0,217 ₺
ELX CY 23015	1,5	Siyah	Kırmızı	8	14	500	0,264 ₺
ELX CY 23025	2,5	Gri	Mavi	10	14	250	0,433 ₺
ELX CY 23040	4	Turuncu	Gri	12	17	200	0,504 ₺
ELX CY 23060	6	Yeşil	Siyah	14	20	100	0,626 ₺
ELX CY 23100	10	Kahverengi	Beyaz	14	27	100	0,956 ₺
ELX CY 23160	16	Bej	Yeşil	14	31	50	1,188 ₺

Standart : DIN 46228
 Malzeme : Bakır Kalay Kaplı
 İzolasyon : Naylon



İzoleli Papuçlar

İzoleli 0,50-1,50 Kablo Girişli Yuvarlak Papuçlar

Standart : DIN 46237
Malzeme : Bakır Kalay Kaplı
İzolasyon : PVC
Çalışma Sıcaklığı : Max 105°
600 Volt Arası



Teknik Özellikler

ÜRÜN KODU	RENK	KESİT	K. ADEDİ	AÇIKLAMA	FİYAT
ELX YU 301	■ Kırmızı	0,50 - 1,5	200	M 3 İzoleli Papuçlar	0,346 ₺
ELX YU 401	■ Kırmızı	0,50 - 1,5	200	M 4 İzoleli Papuçlar	0,520 ₺
ELX YU 501	■ Kırmızı	0,50 - 1,5	200	M 5 İzoleli Papuçlar	0,530 ₺
ELX YU 601	■ Kırmızı	0,50 - 1,5	200	M 6 İzoleli Papuçlar	0,775 ₺
ELX YU 801	■ Kırmızı	0,50 - 1,5	200	M 8 İzoleli Papuçlar	0,779 ₺

İzoleli 0,50-250 Kablo Girişli Yuvarlak Papuçlar



Teknik Özellikler

ÜRÜN KODU	RENK	KESİT	K. ADEDİ	AÇIKLAMA	FİYAT
ELX YU 302	■ Mavi	1,50 - 2,5	200	M 3 İzoleli Papuçlar	0,590 ₺
ELX YU 402	■ Mavi	1,50 - 2,5	200	M 4 İzoleli Papuçlar	0,590 ₺
ELX YU 502	■ Mavi	1,50 - 2,5	200	M 5 İzoleli Papuçlar	0,600 ₺
ELX YU 602	■ Mavi	1,50 - 2,5	200	M 6 İzoleli Papuçlar	0,850 ₺
ELX YU 802	■ Mavi	1,50 - 2,5	200	M 8 İzoleli Papuçlar	0,850 ₺
ELX YU 1002	■ Mavi	1,50 - 2,5	200	M 10 İzoleli Papuçlar	0,860 ₺

İzoleli 4,0 - 6,0 Kablo Girişli Yuvarlak Papuçlar



Teknik Özellikler

ÜRÜN KODU	RENK	KESİT	K. ADEDİ	AÇIKLAMA	FİYAT
ELX YU 406	■ Sarı	4,0 - 6,0	100	M 4 İzoleli Papuçlar	1,38 ₺
ELX YU 506	■ Sarı	4,0 - 6,0	100	M 5 İzoleli Papuçlar	1,38 ₺
ELX YU 606	■ Sarı	4,0 - 6,0	100	M 6 İzoleli Papuçlar	1,55 ₺
ELX YU 806	■ Sarı	4,0 - 6,0	100	M 8 İzoleli Papuçlar	1,940 ₺
ELX YU 1006	■ Sarı	4,0 - 6,0	100	M 10 İzoleli Papuçlar	1,950 ₺
ELX YU 1206	■ Sarı	4,0 - 6,0	100	M 12 İzoleli Papuçlar	1,970 ₺

İzoleli 0,50 - 1,5 Kablo Girişli Çatal Papuçlar

Standart : DIN 46237
Malzeme : Bakır Kalay Kaplı
İzolasyon : PVC
Çalışma Sıcaklığı : Max 105°
600 Volt Arası



Teknik Özellikler

ÜRÜN KODU	RENK	KESİT	K. ADEDİ	AÇIKLAMA	FİYAT
ELX ÇU 3001	■ Kırmızı	0,50 - 1,5	200	M 3 İzoleli Papuçlar	0,495 ₺
ELX ÇU 4001	■ Kırmızı	0,50 - 1,5	200	M 4 İzoleli Papuçlar	0,505 ₺
ELX ÇU 5001	■ Kırmızı	0,50 - 1,5	200	M 5 İzoleli Papuçlar	0,519 ₺
ELX ÇU 6001	■ Kırmızı	0,50 - 1,5	200	M 6 İzoleli Papuçlar	0,577 ₺

İzoleli Pabuçlar

İzoleli 1,50 - 2,5 Kablo Girişli Çatal Pabuçlar



Teknik Özellikler

ÜRÜN KODU	RENK	KESİT	K. ADEDİ	AÇIKLAMA	FİYAT
ELX ÇU 3002	Mavi	1,5 - 2,5	200	M 3 İzoleli Pabuçlar	0,540 ₺
ELX ÇU 4002	Mavi	1,5 - 2,5	200	M 4 İzoleli Pabuçlar	0,560 ₺
ELX ÇU 5002	Mavi	1,5 - 2,5	200	M 5 İzoleli Pabuçlar	0,565 ₺
ELX ÇU 6002	Mavi	1,5 - 2,5	200	M 6 İzoleli Pabuçlar	0,759 ₺

İzoleli 4,0 - 6,0 Kablo Girişli Çatal Pabuçlar



Teknik Özellikler

ÜRÜN KODU	RENK	KESİT	K. ADEDİ	AÇIKLAMA	FİYAT
ELX ÇU 4006	Sarı	4,0 - 6,0	100	M 4 İzoleli Pabuçlar	1,250 ₺
ELX ÇU 5006	Sarı	4,0 - 6,0	100	M 5 İzoleli Pabuçlar	1,280 ₺
ELX ÇU 6006	Sarı	4,0 - 6,0	100	M 6 İzoleli Pabuçlar	1,70 ₺
ELX ÇU 8006	Sarı	4,0 - 6,0	100	M 8 İzoleli Pabuçlar	1,95 ₺

İğne Tip İzoleli Kablo Uçları



Teknik Özellikler

Malzeme : Bakır Kalay Kaplı
İzolasyon : PVC
Çalışma Sıcaklığı : Max 75° / 300 Volt Arası

ÜRÜN KODU	RENK	KESİT	K. ADEDİ	AÇIKLAMA	FİYAT
ELX K 101	Kırmızı	0,5 - 1,5	200	1,9 x 10,5 Kablo Uçları	0,569 ₺
ELX K 102	Mavi	1,5 - 2,5	200	1,9 x 20,5 Kablo Uçları	0,670 ₺
ELX K 106	Sarı	4,0 - 6,0	200	2,8 x 26 Kablo Uçları	1,60 ₺

Kurşun Tip Dişi Terminal



Teknik Özellikler

Malzeme : Pirinç, Kalay Kaplı
Bakır Yüksüklü
İzolasyon : PVC
Çalışma Sıcaklığı : Max 75° / 300 Volt Arası

ÜRÜN KODU	RENK	KESİT	K. ADEDİ	AÇIKLAMA	FİYAT
ELX BD 1040	Kırmızı	0,5 - 1,5	200	Q4 L9 Dişi Terminal	1,520 ₺
ELX BD 2050	Mavi	1,5 - 2,5	200	Q5 L9 Dişi Terminal	1,70 ₺
ELX BD 5050	Sarı	4,0 - 6,0	100	Q5 L9 Dişi Terminal	2,10 ₺

Terminal



Kurşun Tip Erkek Terminal



Teknik Özellikler

Malzeme : Pirinç, Kalay Kaplı
Bakır Yüksüklü
İzolasyon : PVC
Çalışma Sıcaklığı : Max 75° / 300 Volt Arası

ÜRÜN KODU	RENK	KESİT	K. ADEDİ	AÇIKLAMA	FİYAT
ELX BE 1040	■ Kırmızı	0,5 - 1,5	200	Q4 L8,5 Erkek Terminal	1,27 ₺
ELX BE 2050	■ Mavi	1,5 - 2,5	200	Q5 L8,5 Erkek Terminal	1,45 ₺
ELX BE 5050	■ Sarı	4,0 - 6,0	100	Q5 L8,5 Erkek Terminal	1,95 ₺

Polyamid Tam İzole Bayrak Tip Terminal



Teknik Özellikler

Malzeme : Pirinç, Kalay Kaplı
İzolasyon : Polyamid
Çalışma Sıcaklığı : Max 105° / 300 Volt Arası

ÜRÜN KODU	RENK	KESİT	K. ADEDİ	AÇIKLAMA	FİYAT
ELX FDEB 1861	■ Kırmızı	0,50 - 1,5	100	6,3 mm Terrminal	1,550 ₺
ELX FDEB 2862	■ Mavi	1,5 - 2,5	100	6,3 mm Terrminal	1,550 ₺

Tam İzole PVC Dişi Terminal



Teknik Özellikler

Malzeme : Pirinç, Kalay Kaplı
İzolasyon : PVC
Çalışma Sıcaklığı : Max 75° / 300 Volt Arası

ÜRÜN KODU	RENK	KESİT	K. ADEDİ	AÇIKLAMA	FİYAT
ELX FFD 1488	■ Kırmızı	0,5 - 1,5	200	4,8 mm	0,700 ₺
ELX FFD 1638	■ Kırmızı	0,5 - 1,5	200	6,3 mm	0,940 ₺
ELX FFD 2488	■ Mavi	1,5 - 2,5	200	4,8 mm	0,720 ₺
ELX FFD 2638	■ Mavi	1,5 - 2,5	200	6,3 mm	0,940 ₺
ELX FFD 5638	■ Sarı	4,0 - 6,0	100	6,3 mm	1,030 ₺

Terminal

İzoleli Dişi Terminal

Malzeme : Pirinç, Kalay Kaplı
İzolasyon : PVC
Çalışma Sıcaklığı : Max 75° / 300 Volt Arası

Teknik Özellikler



ÜRÜN KODU	RENK	KESİT	K. ADEDİ	AÇIKLAMA	FİYAT
ELX FD 1488	■ Kırmızı	0,5-1,5	200	4,8 mm Dişi Terminal	0,550 ₺
ELX FD 1638	■ Kırmızı	0,5-1,5	200	6,3 mm Dişi Terminal	0,710 ₺
ELX FD 2638	■ Mavi	1,5-2,5	200	6,3 mm Dişi Terminal	0,710 ₺
ELX FD 5638	■ Sarı	4,0-6,0	150	6,3 mm Dişi Terminal	0,870 ₺



Terminal

İzoleli Erkek Terminal



Teknik Özellikler

Malzeme : Pirinç, Kalay Kaplı
İzolasyon : PVC
Çalışma Sıcaklığı : Max 75° /300 Volt Arası

ÜRÜN KODU	RENK	KESİT	K. ADEDİ	AÇIKLAMA	FİYAT
ELX FE 1288	Kırmızı	0,5 - 1,5	200	2,8 mm Terminal	0,490 ₺
ELX FE 1488	Kırmızı	0,5 - 1,5	200	4,8 mm Terminal	0,490 ₺
ELX FE 1638	Kırmızı	0,5 - 1,5	200	6,3 mm Terminal	0,590 ₺
ELX FE 2488	Mavi	1,5 - 2,5	200	4,8 mm Terminal	0,490 ₺
ELX FE 2638	Mavi	1,5 - 2,5	200	6,3 mm Terminal	0,650 ₺
ELX FE 5638	Sarı	4,0 - 6,0	150	6,3 mm Terminal	0,770 ₺

İzolesiz Dişi Terminal



Teknik Özellikler

ÜRÜN KODU	K. ADEDİ	AÇIKLAMA	FİYAT
ELX SF 1D	300	6,3 Dişi Terminal	0,592 ₺
ELX SF 2D	300	6,3 Dişi Tırnaklı Terminal	0,592 ₺
ELX SF 1/2D	1000	2,8 Dişi Terminal	0,362 ₺
ELX SF 1D Mini	500	4,8 Dişi Terminal	0,459 ₺
ELX SF 1D Kılıf	300	6,3 Terminal Kılıfı	0,281 ₺

İzolesiz Erkek Terminal



Teknik Özellikler

ÜRÜN KODU	K. ADEDİ	AÇIKLAMA	FİYAT
ELX SF 1EÇK	300	6,3 Kısa Erkek Terminal	0,611 ₺
ELX SF 1EU1	400	6,3 Uzun Erkek Terminal	0,769 ₺

İzolesiz Erkek Terminal



Teknik Özellikler

ÜRÜN KODU	K. ADEDİ	AÇIKLAMA	FİYAT
ELX SKN 2,5	500	M4 M5 M6 Topraklama Terminal	0,586 ₺
ELX SKN 4	250	M4 M5 M6 Topraklama Terminal	1,107 ₺
ELX SKN 6	150	M6 Topraklama Terminal	1,690 ₺
ELX SKN 8	150	M8 Topraklama Terminal	1,690 ₺
ELX SKN 10	100	M8 M10 Topraklama Terminal	1,932 ₺

Ekonomik Kablo Pabuçları

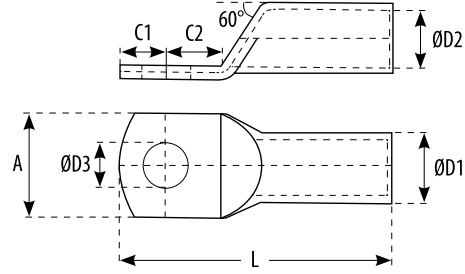
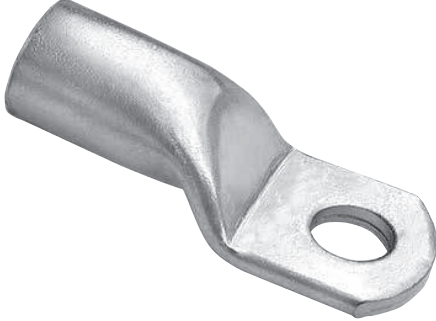

Elektrolit Bakır 99.9
İletkenlik Katsayı min. 56 ms/m

Ürün Kodu	Kablo Kesiti mm2	Civata	Ölçüler					Kutu Adet	Adet Fiyat (USD)
			D3	D2	D1	L	A		
SKPE-16-06	16	M6	6,5	5,8	7,4	30	12	500	0,266 \$
SKPE-16-08	16	M6	6,5	5,8	7,4	30	12	500	0,266 \$
SKPE-25-08	25	M8	8,5	7,2	9,2	40	14	350	0,52 \$
SKPE-35-08	35	M8	8,5	8,5	11	44	15,3	200	0,71 \$
SKPE-50-10	50	M10	10,5	10	13	52	20	150	0,94 \$
SKPE-70-10	70	M10	10,5	11,5	14,7	55	22	100	1,46 \$
SKPE-95-12	95	M12	13	13,5	16,7	59	26	80	1,76 \$
SKPE-120-12	120	M12	13	15,6	19	70	29	50	2,44 \$
SKPE-150-12	150	M12	13	17	21	77	32	40	3,82 \$
SKPE-185-16	185	M16	17	19	23	85	35	30	4,61 \$
SKPE-240-16	240	M16	17	21	26	90	38,5	25	7,02 \$

Ek Muflar

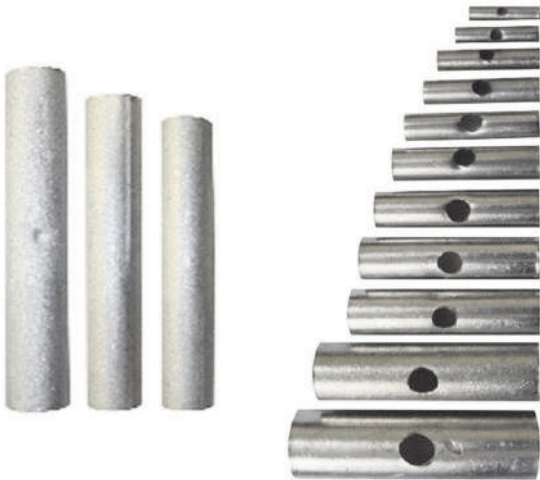

Ürün Kodu	Uzunluk mm2	Kutu Adet	Adet Fiyat (USD)
EM-16	32	400	0,266 \$
EM-25	41	250	0,506 \$
EM-35	46	200	0,663 \$
EM-50	54	150	0,852 \$
EM-70	58	100	1,42 \$
EM-95	62	75	1,64 \$
EM-120	74	60	2,37 \$
EM-150	80	40	3,68 \$
EM-185	86	25	4,86 \$
EM-240	95	25	6,75 \$

Kablo Pabuçları

Ürün Kodu	Kablo Kesiti mm2	Civata	Ölçüler					Kutu Adet	Adet Fiyat (USD)
			D3	D2	D1	L	A		
SKPS-10-06	10	M6	6,5	4,7	6,5	27,5	10,5	800	0,266 \$
SKPS-10-08		M8	8,5	4,7	6,5	27,5	13,0	800	0,288 \$
SKPS-16-06	16	M6	6,5	5,8	7,4	30	12	500	0,37 \$
SKPS-16-08		M8	8,5	5,8	7,8	30	12	500	0,41 \$
SKPS-25-06	25	M6	6,5	7,0	9,2	40	14	350	0,694 \$
SKPS-25-08		M8	8,5	7,0	9,2	40	14	350	0,694 \$
SKPS-25-10		M10	10,5	7,0	9,5	40	14	350	0,694 \$
SKPS-35-06	35	M6	6,5	8,2	10,7	44	15,3	200	0,947 \$
SKPS-35-08		M8	8,5	8,2	10,7	44	15,3	200	0,947 \$
SKPS-35-10		M10	10,5	8,2	10,7	44	15,3	200	1,028 \$
SKPS-50-08	50	M6	8,5	10,2	12,8	52	20	150	1,44 \$
SKPS-50-10		M10	10,5	10,2	12,8	52	20	150	1,44 \$
SKPS-50-12		M12	13	10,2	12,8	52	20	150	1,44 \$
SKPS-70-08	70	M8	8,5	11,7	14,7	55	22	100	1,97 \$
SKPS-70-10		M10	10,5	11,7	14,7	55	22	100	1,85 \$
SKPS-70-12		M12	13	11,7	14,7	55	22	100	1,85 \$
SKPS-95-08	95	M8	8,5	13,6	16,7	59	26	80	2,37 \$
SKPS-95-10		M10	10,5	13,6	16,7	59	26	80	2,37 \$
SKPS-95-12		M12	13	13,6	16,7	59	26	80	2,37 \$
SKPS-120-10	120	M10	10,5	15,5	19	70	29	50	3,315 \$
SKPS-120-12		M12	13	15,5	19	70	29	50	3,315 \$
SKPS-150-10	150	M10	10,5	16,7	21	77	32	40	4,93 \$
SKPS-150-12		M12	13	16,7	21	77	32	40	4,93 \$
SKPS-185-10	185	M10	10,5	18,8	23	85	35	30	6,09 \$
SKPS-185-12		M12	13	18,8	23	85	35	30	6,09 \$
SKPS-185-16		M16	17	18,8	23	85	35	30	6,09 \$
SKPS-240-10	240	M10	10,5	21,2	26	90	38,5	25	8,33 \$
SKPS-240-12		M12	13	21,2	26	90	38,5	25	8,33 \$
SKPS-240-16		M16	17	21,2	26	90	38,5	25	8,33 \$

Bimetal(AI-Cu) SKP Kablo Pabucu

Ürün Kodu	Kablo Kesiti mm2	Kutu Adet	Adet Fiyat (USD)
ELXB-SKP-16	16	50	3,18 \$
ELXB-SKP-25	25	50	3,18 \$
ELXB-SKP-35	35	50	3,18 \$
ELXB-SKP-50	50	30	4,32 \$
ELXB-SKP-70	70	30	4,32 \$
ELXB-SKP-95	95	30	4,32 \$
ELXB-SKP-120	120	25	7,15 \$
ELXB-SKP-150	150	25	7,15 \$
ELXB-SKP-185	185	20	11,5 \$
ELXB-SKP-240	240	20	11,5 \$





Dağıtım Ünitesi

1 Kutuplu Dağıtım Ünitesi Ray Geçmeli Kapaklı (7x12 mm 125 Amp)

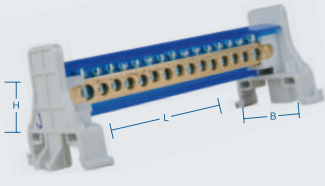

Teknik Özellikler

ÜRÜN KODU	AÇIKLAMA	L	B	H	KOLİ ADEDİ	FİYAT
2007	2 + 5 7 DELİKLİ ÜNİTE	76	44	42	70	51,75 ₺
2010	2 + 8 10 DELİKLİ ÜNİTE	100	44	42	60	60,95 ₺
2012	2 + 10 12 DELİKLİ ÜNİTE	115	44	42	55	72,45 ₺
2015	2 + 13 15 DELİKLİ ÜNİTE	135	44	42	45	81,10 ₺
2020	2 + 18 20 DELİKLİ ÜNİTE	170	44	42	35	113 ₺
2022	2 + 20 22 DELİKLİ ÜNİTE	185	44	42	30	125,5 ₺
2025	2 + 23 25 DELİKLİ ÜNİTE	207	44	42	25	142,1 ₺
2030	2 + 28 30 DELİKLİ ÜNİTE	245	44	42	25	162,1 ₺

2 Kutuplu Dağıtım Ünitesi (7x12 mm 125 Amp)

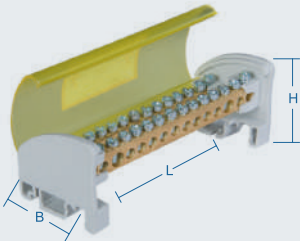

Teknik Özellikler

ÜRÜN KODU	AÇIKLAMA	L	B	H	KOLİ ADEDİ	FİYAT
1407	2 + 5 7 DELİKLİ GAĞITIM ÜNİTESİ	65	45	47	22	106,9 ₺
1410	2 + 8 10 DELİKLİ GAĞITIM ÜNİTESİ	88	45	47	15	119,6 ₺
1412	2 + 10 12 DELİKLİ GAĞITIM ÜNİTESİ	102	45	47	14	133,4 ₺
1415	2 + 13 15 DELİKLİ GAĞITIM ÜNİTESİ	126	45	47	12	172,5 ₺
1420	2 + 18 20 DELİKLİ GAĞITIM ÜNİTESİ	162	45	47	6	220,8 ₺
1422	2 + 20 22 DELİKLİ GAĞITIM ÜNİTESİ	175	45	47	6	238,5 ₺

4 Kutuplu Dağıtım Ünitesi (7x12 mm 125 Amp)

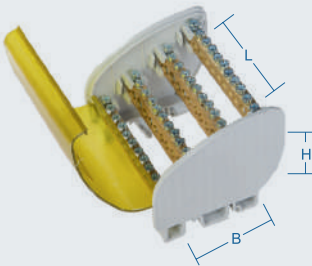

Teknik Özellikler

ÜRÜN KODU	AÇIKLAMA	L	B	H	KOLİ ADEDİ	FİYAT
1507	2 + 5 7 DELİKLİ GAĞITIM ÜNİTESİ	60	80	75	10	213,90 ₺
1510	2 + 8 10 DELİKLİ GAĞITIM ÜNİTESİ	83	80	75	8	227,7 ₺
1512	2 + 10 12 DELİKLİ GAĞITIM ÜNİTESİ	97	80	75	6	258,8 ₺
1515	2 + 13 15 DELİKLİ GAĞITIM ÜNİTESİ	120	80	75	5	316,3 ₺
1520	2 + 18 20 DELİKLİ GAĞITIM ÜNİTESİ	155	80	75	4	414 ₺
1522	2 + 20 22 DELİKLİ GAĞITIM ÜNİTESİ	170	80	75	4	445 ₺
1525	2 + 23 25 DELİKLİ GAĞITIM ÜNİTESİ	191	80	75	4	517,5 ₺

Dağıtım Ünitesi

4 Kutuplu 10x15 Kesit 160 AMP Dağıtıcı Üniteler (Ayak Geçmeli) Alçak Model

Teknik Özellikler

ÜRÜN KODU	AÇIKLAMA	L	B	H	KOLİ ADEDİ	FİYAT
3207	2 + 5 7 DELİKLİ ÜNİTE	105	144	55	12	394,5 ₺
3210	2 + 8 10 DELİKLİ ÜNİTE	145	144	55	8	575 ₺
3212	2 + 10 12 DELİKLİ ÜNİTE	165	144	55	8	680,8 ₺
3215	2 + 13 15 DELİKLİ ÜNİTE	200	144	55	6	845,5 ₺
3220	2 + 18 20 DELİKLİ ÜNİTE	255	144	55	4	1127 ₺
3222	2 + 20 22 DELİKLİ ÜNİTE	275	144	55	4	1145 ₺

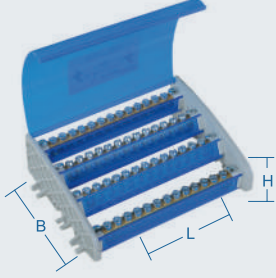

5 Kutuplu 10x15 Kesit 160 AMP Dağıtıcı Üniteler Yüksek Model

Teknik Özellikler

ÜRÜN KODU	AÇIKLAMA	L	B	H	KOLİ ADEDİ	FİYAT
3307	2 + 5 7 DELİKLİ GAĞITIM ÜNİTESİ	105	151	95	8	473,8 ₺
3310	2 + 8 10 DELİKLİ GAĞITIM ÜNİTESİ	145	151	95	4	689,8 ₺
3312	2 + 10 12 DELİKLİ GAĞITIM ÜNİTESİ	165	151	95	4	811,9 ₺
3315	2 + 13 15 DELİKLİ GAĞITIM ÜNİTESİ	200	151	95	4	1014 ₺
3320	2 + 18 20 DELİKLİ GAĞITIM ÜNİTESİ	255	151	95	4	1352 ₺
3322	2 + 20 22 DELİKLİ GAĞITIM ÜNİTESİ	275	151	95	4	1476 ₺

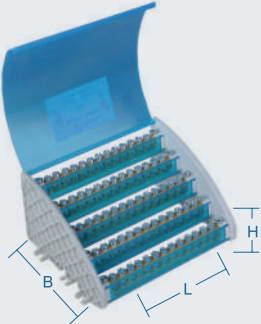

Topraklama Klemensler / WAGO Buat Klemensleri

Pano Topraklama Klemensleri (6x8 mm Kesit 63 Amp.)

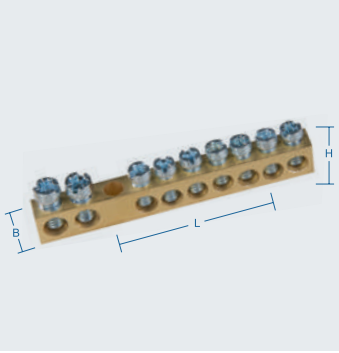

Teknik Özellikler

ÜRÜN KODU	AÇIKLAMA	L	B	H	KOLİ ADEDİ	FİYAT
1004	4 Delikli Topraklama Klemensi	33	6	8	1500	9,78 ₺
1005	5 Delikli Topraklama Klemensi	38	6	8	1500	10,35 ₺
1006	6 Delikli Topraklama Klemensi	45	6	8	1250	13,80 ₺
1007	7 Delikli Topraklama Klemensi	50	6	8	1000	14,50 ₺
1009	9 Delikli Topraklama Klemensi	62	6	8	1000	16,10 ₺
1010	10 Delikli Topraklama Klemensi	68	6	8	750	17,25 ₺
1012	12 Delikli Topraklama Klemensi	80	6	8	750	21,20 ₺

Pano Topraklama Klemensleri Ayaklı (6,5x9 mm Kesit 80 Amp.)

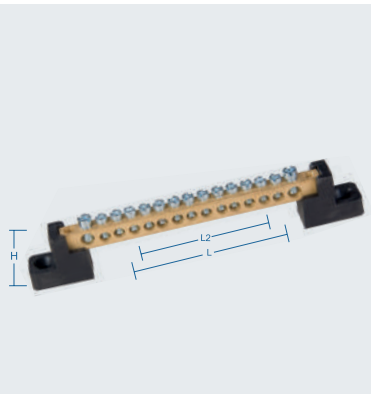

Teknik Özellikler

ÜRÜN KODU	AÇIKLAMA	L	L2	H	KOLİ ADEDİ	FİYAT
1106	6 Delikli Topraklama Klemensi	85	70	22	200	23,00 ₺
1107	7 Delikli Topraklama Klemensi	90	75	22	200	25,50 ₺
1110	10 Delikli Topraklama Klemensi	108	95	22	150	30,40 ₺
1112	12 Delikli Topraklama Klemensi	120	106	22	150	32,90 ₺
1115	15 Delikli Topraklama Klemensi	138	124	22	125	39,90 ₺
1120	20 Delikli Topraklama Klemensi	165	152	22	100	51,95 ₺
1125	25 Delikli Topraklama Klemensi	195	180	22	75	64,90 ₺
1130	30 Delikli Topraklama Klemensi	235	220	22	75	90,80 ₺

WAGO Buat Klemensleri Alev İletmez (1.0-2.5 mm²)









Teknik Özellikler

ÜRÜN KODU	KABLO KESİTİ	AÇIKLAMA	KOLİ ADEDİ	FİYAT
221-412	2 x 4 mm ²	Buat ve çok amaçlı klemens	4 1000	0,627 €
221-413	3 x 4 mm ²	Buat ve çok amaçlı klemens	4 500	0,767 €
221-415	5 x 4 mm ²	Buat ve çok amaçlı klemens	4 250	1,254 €
221-482	2 x 4 mm ²	Buat ve çok amaçlı klemens, EX'ı için uygundur	4 1000	1,127 €
221-483	3 x 4 mm ²	Buat ve çok amaçlı klemens, EX'ı için uygundur	4 500	1,347 €
221-485	5 x 4 mm ²	Buat ve çok amaçlı klemens, EX'ı için uygundur	4 250	1,897 €
221-612	2 x 6 mm ²	Buat ve çok amaçlı klemens	6 500	1,254 €
221-613	3 x 6 mm ²	Buat ve çok amaçlı klemens	6 300	1,504 €
221-615	5 x 6 mm ²	Buat ve çok amaçlı klemens	6 150	2,502 €
221-682	2 x 6 mm ²	Buat ve çok amaçlı klemens, EX'ı için uygundur	6 500	1,718 €
221-683	3 x 6 mm ²	Buat ve çok amaçlı klemens, EX'ı için uygundur	6 300	2,004 €
221-685	5 x 6 mm ²	Buat ve çok amaçlı klemens, EX'ı için uygundur	6 150	2,956 €
2273-202	2 x 2,5 mm ²	Buat klemensi	1,5 1000	0,250 €
2273-203	3 x 2,5 mm ²	Buat klemensi	2,5 1000	0,281 €
2273-204	4 x 2,5 mm ²	Buat klemensi	2,5 1000	0,343 €
2273-205	5 x 2,5 mm ²	Buat klemensi	2,5 1000	0,375 €
2273-208	8 x 2,5 mm ²	Buat klemensi	2,5 100	0,688 €
773-106	6 x 2,5 mm ²	Buat klemensi, mor / saydam	2,5 500	0,767 €
773-173	3 x 6 mm ²	Buat klemensi, kırmızı / saydam	6 500	1,346 €

Buat Klemensler

Geçmeli Buat Klemensler

Teknik Özellikler

ÜRÜN KODU	KABLO KESİTİ	EN	BOY	YÜKSEKLİK	KOLİ ADEDİ	FİYAT
 ELX2.5-2	0.5-2.5 mm ²	9,9	16,4	6	200	0,119 \$
 ELX2.5-3	0.5-2.5 mm ²	13,9	16,4	6	200	0,138 \$
 ELX2.5-4	0.5-2.5 mm ²	17,9	16,4	6	100	0,158 \$
 ELX2.5-5	0.5-2.5 mm ²	21,9	16,4	6	100	0,172 \$
 ELX2.5-6	0.5-2.5 mm ²	13,9	16,4	11,5	100	0,226 \$
 ELX2.5-8	0.5-2.5 mm ²	17,9	16,4	11,5	50	0,284 \$

Çok Amaçlı Klemensler

Teknik Özellikler

ÜRÜN KODU	KABLO KESİTİ	AÇIKLAMA	KOLİ ADEDİ	FİYAT
 ELX-412	0.14-4 mm ²	2 İletken Bağlantılı	100	0,238 \$
 ELX-413	0.14-4 mm ²	3 İletken Bağlantılı	100	0,315 \$
 ELX-414	0.14-4 mm ²	4 İletken Bağlantılı	100	0,397 \$
 ELX-415	0.14-4 mm ²	5 İletken Bağlantılı	50	0,463 \$

Plastik Kablo Bağları



ÜRÜN KODU	BOYUTLAR		RENK	P. MİKTARI	AÇIKLAMA	FİYAT
	En (mm)	Uzunluk (mm)				
ELX KB 2,5 x 100	2,5	100	Siyah - Beyaz	100	Plastik Kablo Bağları	0.115 ₺
ELX KB 2,5 x 150	2,5	150	Siyah - Beyaz	100	Plastik Kablo Bağları	0.176 ₺
ELX KB 2,5 x 200	2,5	200	Siyah - Beyaz	100	Plastik Kablo Bağları	0.245 ₺
ELX KB 3,6 x 150	3,6	150	Siyah - Beyaz	100	Plastik Kablo Bağları	0.268 ₺
ELX KB 3,6 x 200	3,6	200	Siyah - Beyaz	100	Plastik Kablo Bağları	0.352 ₺
ELX KB 3,6 x 250	3,6	250	Siyah - Beyaz	100	Plastik Kablo Bağları	0.420 ₺
ELX KB 3,6 x 300	3,6	300	Siyah - Beyaz	100	Plastik Kablo Bağları	0.536 ₺
ELX KB 3,6 x 370	3,6	370	Siyah - Beyaz	100	Plastik Kablo Bağları	0.675 ₺
ELX KB 4,8 x 200	4,8	200	Siyah - Beyaz	100	Plastik Kablo Bağları	0.498 ₺
ELX KB 4,8 x 250	4,8	250	Siyah - Beyaz	100	Plastik Kablo Bağları	0.582 ₺
ELX KB 4,8 x 300	4,8	300	Siyah - Beyaz	100	Plastik Kablo Bağları	0.736 ₺
ELX KB 4,8 x 380	4,8	380	Siyah - Beyaz	100	Plastik Kablo Bağları	0.920 ₺
ELX KB 4,8 x 450	4,8	450	Siyah - Beyaz	100	Plastik Kablo Bağları	1.119 ₺
ELX KB 4,8 x 500	4,8	500	Siyah - Beyaz	100	Plastik Kablo Bağları	1.257 ₺
ELX KB 8 x 300	8	300	Siyah - Beyaz	100	Plastik Kablo Bağları	1.364 ₺
ELX KB 8 x 380	8	380	Siyah - Beyaz	100	Plastik Kablo Bağları	1.610 ₺
ELX KB 8 x 450	8	450	Siyah - Beyaz	100	Plastik Kablo Bağları	1.863 ₺
ELX KB 8 x 550	8	550	Siyah - Beyaz	100	Plastik Kablo Bağları	2.514 ₺
ELX KB 8 x 650	8	650	Siyah - Beyaz	100	Plastik Kablo Bağları	3.618 ₺
ELX KB 8x 750	8	750	Siyah - Beyaz	100	Plastik Kablo Bağları	3.97 ₺
ELX KB 9 x 900	8	900	Siyah - Beyaz	100	Plastik Kablo Bağları	7.20 ₺
ELX KB 9 x 950	8	950	Siyah - Beyaz	100	Plastik Kablo Bağları	7.43 ₺
ELX KB 9 x 1000	8	1000	Siyah - Beyaz	100	Plastik Kablo Bağları	7.66 ₺
ELX KB 9 x 1200	8	1200	Siyah - Beyaz	100	Plastik Kablo Bağları	9.04 ₺

Yapışkanlı Kroşeler

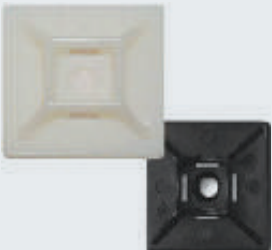

Teknik Özellikler

ÜRÜN KODU	RENK	ÖLÇÜ	K. ADEDİ	AÇIKLAMA	FİYAT
ELX YK20	Beyaz	20 x 20	100	Yapışkanlı Kroşe	0,966 ₺
ELX YK25	Beyaz	25 x 25	100	Yapışkanlı Kroşe	1,311 ₺
ELX YK30	Beyaz	30 x 30	100	Yapışkanlı Kroşe	1,725 ₺
ELX YK40	Beyaz	40 X 40	50	Yapışkanlı Kroşe	3,45 ₺

tbloc

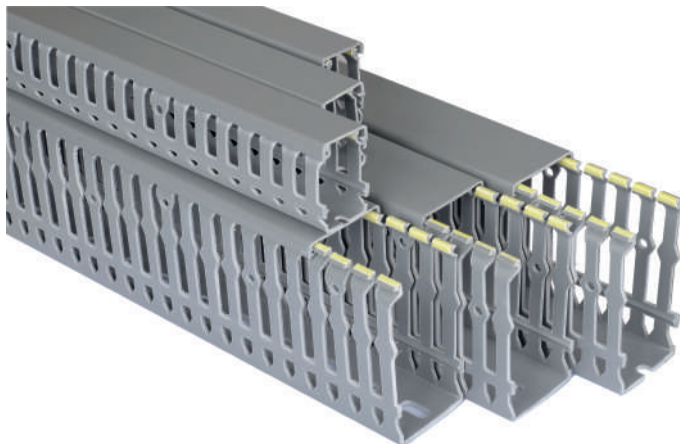
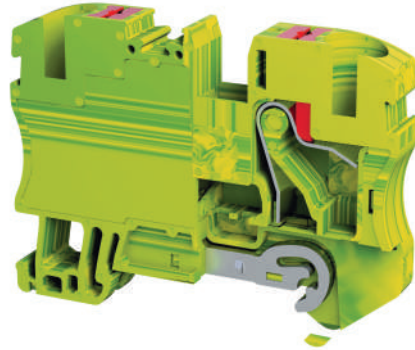
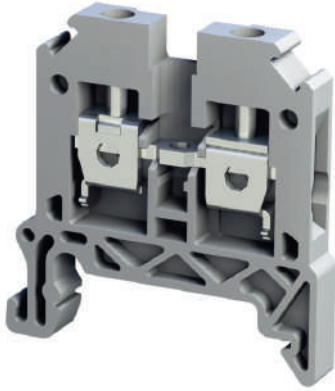
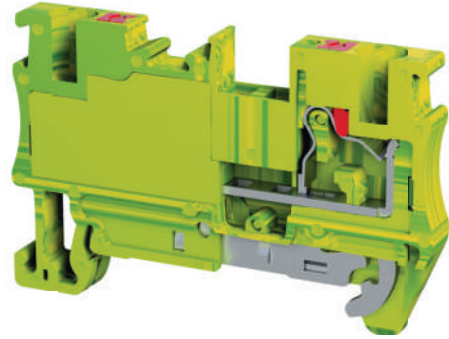
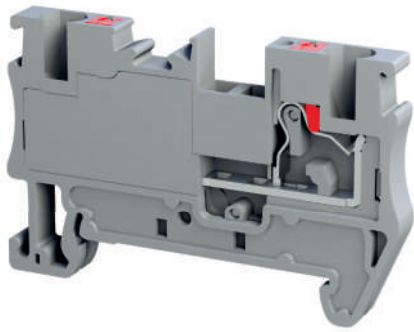

Vinç Kumanda Butonları

COB61

Mekanik Kilitli
Tek Hızlı

FİYAT: 4,0 \$



ÜRÜN KODU	COB61-VK2
AÇIKLAMA	Tek Hızlı 2'li Vinç Kumanda Mekanik Kilitli Kontakt 5A
KUTU ADEDİ	1 Adet

COB62

Mekanik Kilitli
Tek Hızlı

FİYAT: 5,25 \$



ÜRÜN KODU	COB62-VK4
AÇIKLAMA	Tek Hızlı 4'lü Vinç Kumanda Mekanik Kilitli Kontakt 5A
KUTU ADEDİ	1 Adet

COB63

Mekanik Kilitli
Tek Hızlı

FİYAT: 6,875 \$



ÜRÜN KODU	COB63-VK6
AÇIKLAMA	Tek Hızlı 6'lı Vinç Kumanda Mekanik Kilitli Kontakt 5A
KUTU ADEDİ	1 Adet

COB64

Mekanik Kilitli
Tek Hızlı

FİYAT: 9.375 \$



ÜRÜN KODU	COB64-VK8
AÇIKLAMA	Tek Hızlı 8'li Vinç Kumanda Mekanik Kilitli Kontakt 5A
KUTU ADEDİ	1 Adet

COBC1

Mekanik Kilitli - Tek
Hızlı - Faz Bağlantı
Köprülü

FİYAT: 16,25 \$



ÜRÜN KODU	COBC1-VKB3
AÇIKLAMA	Tek Hızlı 2 + Acil Stop Vinç Ku- manda Mekanik Kilitli Kontakt 16A
KUTU ADEDİ	1 Adet

COBC2

Mekanik Kilitli - Tek
Hızlı - Faz Bağlantı
Köprülü

FİYAT: 22,50 \$



ÜRÜN KODU	COBC2-VKB5
AÇIKLAMA	Tek Hızlı 4 + Acil Stop Vinç Ku- manda Mekanik Kilitli Kontakt 16A
KUTU ADEDİ	1 Adet

COBC3

Mekanik Kilitli - Tek
Hızlı - Faz Bağlantı
Köprülü

FİYAT: 29,37 \$



ÜRÜN KODU	COBC3-VKB7
AÇIKLAMA	Tek Hızlı 6 + Acil Stop Vinç Ku- manda Mekanik Kilitli Kontakt 16A
KUTU ADEDİ	1 Adet

COBC4

Mekanik Kilitli - Tek
Hızlı - Faz Bağlantı
Köprülü

FİYAT: 35,00 \$



ÜRÜN KODU	COBC4-VKB8
AÇIKLAMA	Tek Hızlı 8 + Acil Stop Vinç Ku- manda Mekanik Kilitli Kontakt 16A
KUTU ADEDİ	1 Adet

Vinç Kumanda Butonları / Ayak Pedalları

KB 2

Araç Lift Kumanda
Çift Kontaklı

FİYAT: 11,90 \$



ÜRÜN KODU	KB-2
AÇIKLAMA	Lift Kumanda 2'li Tek Hızlı Çift Kontaklı 10A
KUTU ADEDİ	1 Adet

AP-9

Ayak Pedalları
Kablosuz

FİYAT: 36 \$



ÜRÜN KODU	ELX-FSMS/1
KONTAK TİPİ	1NO+1NC
AÇIKLAMA	Döküm Korumalı Kapaklı Pedal Kablosuz
KUTU ADEDİ	1 Adet

AP-9

Ayak Pedalları
2 mt Kablolu

FİYAT: 39,5 \$



ÜRÜN KODU	ELX-FSMS/1
KONTAK TİPİ	1NO+1NC
AÇIKLAMA	Döküm Korumalı Kapaklı Pedal 2 m Kablolu
KUTU ADEDİ	1 Adet

FS-1 METAL

Ayak Pedalları

FİYAT: 6,60 \$



ÜRÜN KODU	FS-1-AP1
KONTAK TİPİ	1NO+1NC
AÇIKLAMA	2 METRE Kablolü Metal Pedal
KUTU ADEDİ	1 Adet

FS-2 METAL

Ayak Pedalları

FİYAT: 8,25 \$



ÜRÜN KODU	FS-2-AP2
KONTAK TİPİ	1NO+1NC
AÇIKLAMA	Kablolu 1 mt Döküm Pedal
KUTU ADEDİ	1 Adet

FS-3 METAL

Ayak Pedalları

FİYAT: 10,00 \$



ÜRÜN KODU	FS-3-AP3
KONTAK TİPİ	1NO+1NC
AÇIKLAMA	Kablolu 1 mt Döküm Pedal
KUTU ADEDİ	1 Adet

LED SPOT | HAREKETLİ REFLEKTÖRLÜ COB



MADE IN TURKEY

5 W - Hareketli Sıva Altı Cob Led Spot

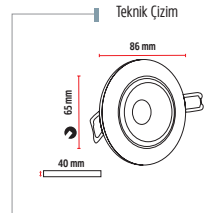

ÜRÜN KODU	GÜÇ	IŞIK RENGİ
ELX-LED-5-SNB	5 W	6500 K

IŞIK AKISI	ÖLÇÜLER			K. MİKTARI
	a	b	c	
450 lm	86	65	40	100 Adet

IŞIK AÇISI	120°
GERİLİM	220 - 240 V
GÖVDE	Alüminyum
KASA RENGİ	Saten Nikel
IP / CLASS	IP20, Class I
LED MODEL	SMD LED
ÖMÜR	30.000 hr

FİYAT: 5,76 \$

LED AMPUL | YÜKSEK GÜÇ

FİYAT: 3,90 \$



18 W - Led Ampul

ÜRÜN KODU	GÜÇ	IŞIK RENGİ	IŞIK AKISI	ÖLÇÜLER			K. MİKTARI
				a	b	c	
ELX-LED-18B	18 W	Beyaz 6500 K	1600 lm	80	145	-	100 Adet

HUZME AÇISI	180°
GERİLİM	220 - 240 V
GÖVDE	Plastik
EQW	135 W

IP / CLASS	IP20, Class I
LED MODEL	SMD LED
ÖMÜR	30.000 hr
DUY	E27

NOMİNAL LAMBA GÜÇ DEĞERİ (W)	18 W
ENERJİ TÜKETİMİ (kWh/1000h)	18 kWh/1000h

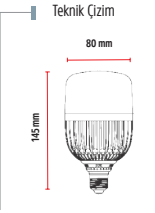

FİYAT: 4,10 \$



28 W - Led Ampul

ÜRÜN KODU	GÜÇ	IŞIK RENGİ	IŞIK AKISI	ÖLÇÜLER			K. MİKTARI
				a	b	c	
ELX-LED-28B	28 W	Beyaz 6500 K	2400 lm	100	185	-	50 Adet

HUZME AÇISI	180°
GERİLİM	220 - 240 V
GÖVDE	Plastik
EQW	210 W

IP / CLASS	IP20, Class I
LED MODEL	SMD LED
ÖMÜR	30.000 hr
DUY	E27

NOMİNAL LAMBA GÜÇ DEĞERİ (W)	28 W
ENERJİ TÜKETİMİ (kWh/1000h)	28 kWh/1000h

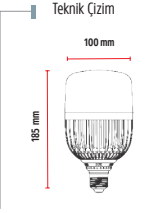

9 W - A60 Led Ampul

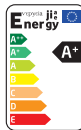

ÜRÜN KODU	GÜÇ	IŞIK RENGİ	IŞIK AKISI	ÖLÇÜLER			K. MİKTARI	FİYAT
				a	b	c		
ELX-LED9B	9 W	Beyaz 6500 K	720 lm	60	108	-	100 Adet	1,14 \$

HUZME AÇISI	160°
GERİLİM	220 - 240 V
GÖVDE	Plastik
EQW	60 W

IP / CLASS	IP20, Class I
LED MODEL	SMD LED
ÖMÜR	30.000 hr
DUY	E27

NOMİNAL LAMBA GÜÇ DEĞERİ (W)	9 W
ENERJİ TÜKETİMİ (kWh/1000h)	9 kWh/1000h

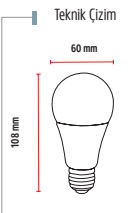

LED ARMATÜR | T5 BANT ARMATÜR

MADE IN TURKEY

6 W - T5 Anahtarlı, Ledli Bant Armatür Kablolu

FİYAT: 6,20 \$

ÜRÜN KODU	GÜÇ	IŞIK RENGİ	IŞIK AKISI	ÖLÇÜLER			K. MİKTARI
				a	b	c	
ELX-LTFA-6W	6 W	Beyaz 6500 K	400 lm	300	-	-	100 Adet

HUZME AÇISI	120°
GERİLİM	220 - 240 V
GÖVDE	Alüminyum

IP / CLASS	IP20, Class I
LED MODEL	SMD LED
ÖMÜR	30.000 hr

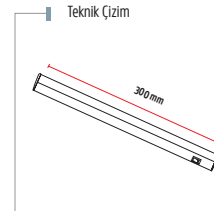
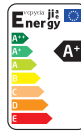

10 W - T5 Anahtarlı, Ledli Bant Armatür Kablolu

FİYAT: 9,05 \$

ÜRÜN KODU	GÜÇ	IŞIK RENGİ	IŞIK AKISI	ÖLÇÜLER			K. MİKTARI
				a	b	c	
ELX-LTFA-10W	10 W	Beyaz 6500 K	640 lm	600	-	-	30 Adet

HUZME AÇISI	120°
GERİLİM	220 - 240 V
GÖVDE	Alüminyum

IP / CLASS	IP20, Class I
LED MODEL	SMD LED
ÖMÜR	30.000 hr

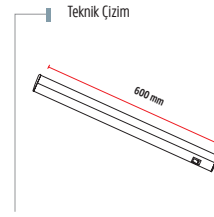
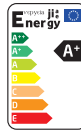

12 W - T5 Anahtarlı, Ledli Bant Armatür Kablolu

FİYAT: 10,70 \$

ÜRÜN KODU	GÜÇ	IŞIK RENGİ	IŞIK AKISI	ÖLÇÜLER			K. MİKTARI
				a	b	c	
ELX-LTFA-12W	12 W	Beyaz 6500 K	960 lm	900	-	-	30 Adet

HUZME AÇISI	120°
GERİLİM	220 - 240 V
GÖVDE	Alüminyum

IP / CLASS	IP20, Class I
LED MODEL	SMD LED
ÖMÜR	30.000 hr

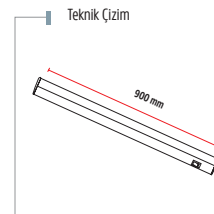
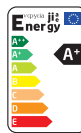

LED ARMATÜR | T5 - YATAY BANT - NEMLIYER ETANJ

MADE IN TURKEY

FİYAT: 12,35 \$



16 W - T5 Anahtarlı, Ledli Bant Armatür Kablolu

ÜRÜN KODU	GÜÇ	IŞIK RENGİ	IŞIK AKISI	ÖLÇÜLER			K. MİKTARI
				a	b	c	
ELX-LTFA-16W	16 W	Beyaz 6500 K	1280 lm	1200	-	-	50 Adet

HUZME AÇISI	120°
GERİLİM	220 - 240 V
GÖVDE	Alüminyum

IP / CLASS	IP20, Class I
LED MODEL	SMD LED
ÖMÜR	30.000 hr

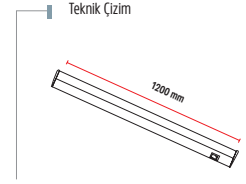
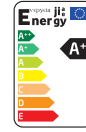

FİYAT: 7,70 \$



20 W - Ledli, Yatay Bant Armatür

ÜRÜN KODU	GÜÇ	IŞIK RENGİ	IŞIK AKISI	ÖLÇÜLER			K. MİKTARI
				a	b	c	
ELX-LTFA-20W	20 W	Beyaz 6500 K	1440 lm	600	75	25	50 Adet

HUZME AÇISI	120°
GERİLİM	220 - 240 V
GÖVDE	Alüminyum

IP / CLASS	IP20, Class I
LED MODEL	SMD LED
ÖMÜR	30.000 hr

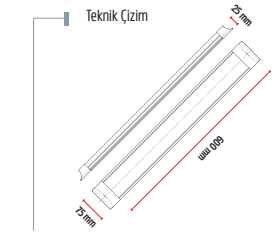

FİYAT: 8,15 \$

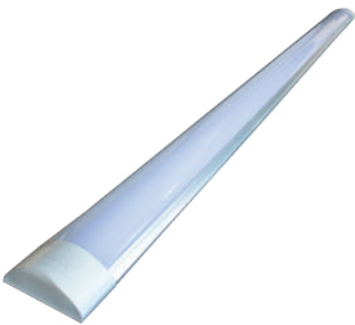

40 W - Ledli, Yatay Bant Armatür

ÜRÜN KODU	GÜÇ	IŞIK RENGİ	IŞIK AKISI	ÖLÇÜLER			K. MİKTARI
				a	b	c	
ELX-LTFA-40W	40 W	Beyaz 6500 K	2880 lm	1200	75	25	24 Adet

HUZME AÇISI	120°
GERİLİM	220 - 240 V
GÖVDE	Alüminyum

IP / CLASS	IP20, Class I
LED MODEL	SMD LED
ÖMÜR	30.000 hr

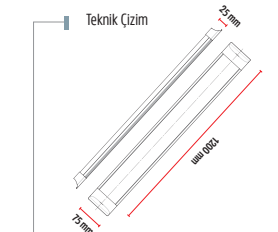

FİYAT: 18,10 \$



36 W - Nemliyer Etanj Led Armatür / Led Waterproof Armature

ÜRÜN KODU	GÜÇ	IŞIK RENGİ	IŞIK AKISI	ÖLÇÜLER			K. MİKTARI
				a	b	c	
ELX-LEA-36W	36 W	Beyaz 6500 K	3200 lm	1200	70	35	30 Adet

HUZME AÇISI	120°
GERİLİM	220 - 240 V
GÖVDE	Alüminyum

IP / CLASS	IP65, Class I
LED MODEL	SMD LED
ÖMÜR	30.000 hr

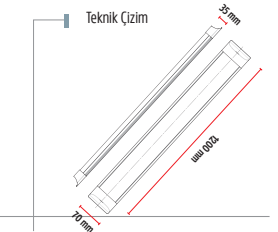

LED TRAFOLAR | İÇ MEKAN



25 W - İç Mekan Led Trafosu

FİYAT: 7,70 \$

ÜRÜN KODU	GÜÇ	ÖLÇÜLER			K. MİKTARI
		a	b	c	
ELX-TR-25	25 W	57	85	33	100 Adet

GİRİŞ GERİLİMİ	220 V
ÇIKIŞ GERİLİMİ	12 V
AKIM	2.1 A
IP / CLASS	IP20, Class I

Teknik Çizim

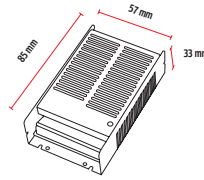

35 W - İç Mekan Led Trafosu

FİYAT: 8,25 \$

ÜRÜN KODU	GÜÇ	ÖLÇÜLER			K. MİKTARI
		a	b	c	
ELX-TR-35	35 W	57	85	33	100 Adet

GİRİŞ GERİLİMİ	220 V
ÇIKIŞ GERİLİMİ	12 V
AKIM	3 A
IP / CLASS	IP20, Class I

Teknik Çizim

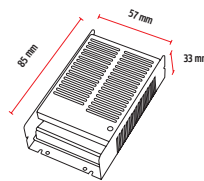

LED TRAFOLAR | İÇ MEKAN - DIŞ MEKAN

FİYAT: 15,65 \$

150 W - İç Mekan Led Trafosu



ÜRÜN KODU	GÜÇ	ÖLÇÜLER			K. MİKTARI
		a	b	c	
ELX-TR-150	150 W	98	199	42	50 Adet

GİRİŞ GERİLİMİ	220 V
ÇIKIŞ GERİLİMİ	12 V
AKIM	12.5 A
IP / CLASS	IP20, Class I

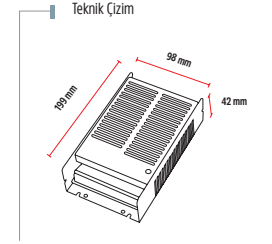

FİYAT: 19,75 \$

200 W - İç Mekan Led Trafosu



ÜRÜN KODU	GÜÇ	ÖLÇÜLER			K. MİKTARI
		a	b	c	
ELX-TR-200	200 W	98	199	42	50 Adet

GİRİŞ GERİLİMİ	220 V
ÇIKIŞ GERİLİMİ	12 V
AKIM	17 A
IP / CLASS	IP20

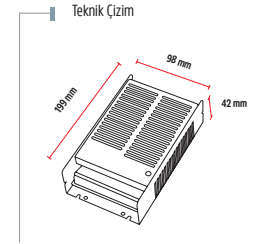

FİYAT: 12,35 \$

30 W - Dış Mekan Led Trafosu



ÜRÜN KODU	GÜÇ	ÖLÇÜLER			K. MİKTARI
		a	b	c	
ELX-TR-DM-30	30 W	30	200	20	50 Adet

GİRİŞ GERİLİMİ	220 V
ÇIKIŞ GERİLİMİ	12 V
AKIM	2.5 A
IP / CLASS	IP65, Class I

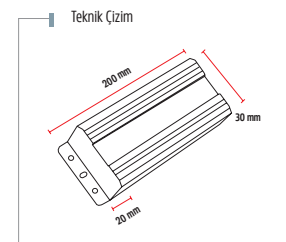

LED TRAFOLAR | SLİM İÇ MEKAN

60 W - Slim İç Mekan Led Trafosu

FİYAT: 9,46 \$

ÜRÜN KODU	GÜÇ	ÖLÇÜLER			K. MİKTARI
		a	b	c	
ELX-TR-60S	60 W	40	160	32	100 Adet

GİRİŞ GERİLİMİ	220 V
ÇIKIŞ GERİLİMİ	12 V
AKIM	5.0 A
IP / CLASS	IP20, Class I

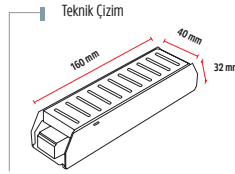

120 W - Slim İç Mekan Led Trafosu

FİYAT: 13,58 \$

ÜRÜN KODU	GÜÇ	ÖLÇÜLER			K. MİKTARI
		a	b	c	
ELX-TR-120S	120 W	45	188	35	50 Adet

GİRİŞ GERİLİMİ	220 V
ÇIKIŞ GERİLİMİ	12 V
AKIM	10 A
IP / CLASS	IP20, Class I

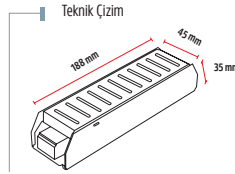

150 W - Slim İç Mekan Led Trafosu

FİYAT: 15,65 \$

ÜRÜN KODU	GÜÇ	ÖLÇÜLER			K. MİKTARI
		a	b	c	
ELX-TR-150S	150 W	58	200	39	50 Adet

GİRİŞ GERİLİMİ	220 V
ÇIKIŞ GERİLİMİ	12 V
AKIM	12.5 A
IP / CLASS	IP20, Class I

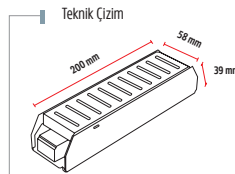

LED TRAFOLAR | SLİM İÇ MEKAN

FİYAT: 19,75 \$

200 W - Slim İç Mekan Led Trafosu



FANSIZ

ÜRÜN KODU	GÜÇ	ÖLÇÜLER			K. MİKTARI
		a	b	c	
ELX-TR-200S	200 W	58	200	40	40 Adet

GİRİŞ GERİLİMİ	220 V
ÇIKIŞ GERİLİMİ	12 V
AKIM	16,5 A
IP / CLASS	IP20, Class I

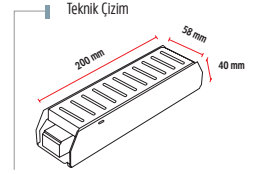

FİYAT: 22,20 \$

250 W - Slim İç Mekan Led Trafosu



FANSIZ

ÜRÜN KODU	GÜÇ	ÖLÇÜLER			K. MİKTARI
		a	b	c	
ELX-TR-250S	250 W	68	223	40	30 Adet

GİRİŞ GERİLİMİ	220 V
ÇIKIŞ GERİLİMİ	12 V
AKIM	20 A
IP / CLASS	IP20, Class I

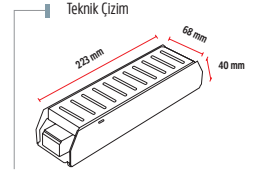

FİYAT: 27,70 \$

350 W - Slim İç Mekan Led Trafosu



FANSIZ

ÜRÜN KODU	GÜÇ	ÖLÇÜLER			K. MİKTARI
		a	b	c	
ELX-TR-350S	350 W	68	223	40	30 Adet

GİRİŞ GERİLİMİ	220 V
ÇIKIŞ GERİLİMİ	12 V
AKIM	30 A
IP / CLASS	IP20, Class I

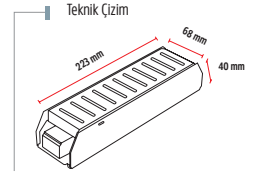

FİYAT: 33 \$

450 W - Slim İç Mekan Led Trafosu



ÜRÜN KODU	GÜÇ	ÖLÇÜLER			K. MİKTARI
		a	b	c	
ELX-TR-450S	450 W	50	215	115	30 Adet

GİRİŞ GERİLİMİ	220 V
ÇIKIŞ GERİLİMİ	12 V
AKIM	40 A
IP / CLASS	IP20, Class I

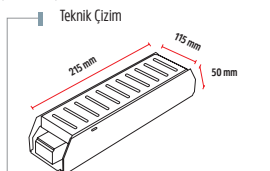

BELGELERİMİZ

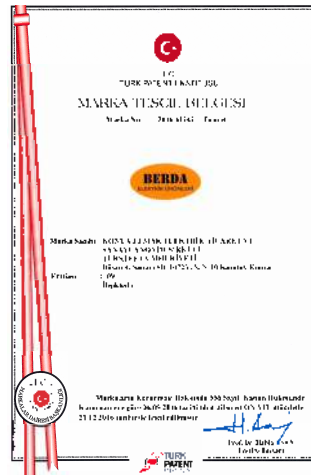
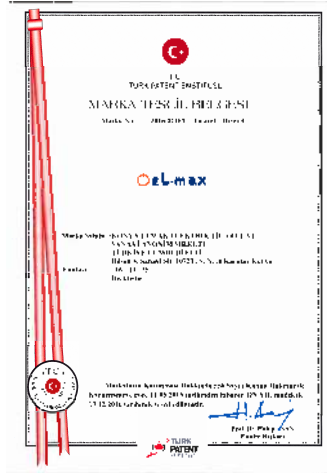

* Bu fiyat listesi Şubat 2022 tarihinden itibaren geçerlidir.
* Fiyatlarımızda herhangi bir gerekçe göstermeksizin değişiklik yapma hakkımız mahfuzdur.
* Faturalamada teslim tarihindeki liste fiyatları geçerlidir.

* Tipografik hatalardan firmamız sorumlu değildir.
* Siparişlerinizde stok sorunuz.
* Fiyatlarımıza KDV dahil değildir.



el-max since 1943

Konya Elmak Elektrik Tic. ve San. A.Ş.
Büsan Organize Sanayi Sitesi 10723 Sokak
No:10 P.K. 42050 Karatay/KONYA
Tel : 0 332 345 18 11
Fax : 0 332 345 18 14

Konya Bölge : 0 530 406 44 59
0 530 602 59 50
0 530 602 63 74
İç Anadolu Bölge : 0 530 406 44 58
Akdeniz Bölge : 0 530 602 59 50
Ege Bölge : 0 530 291 08 42
G. Doğu Bölge : 0 530 140 16 14
Ankara Home Office : 0 530 291 08 42



www.el-max.com.tr